

ARCAM

f·M·J AVR400

HANDBOOK AVR surround amplifier

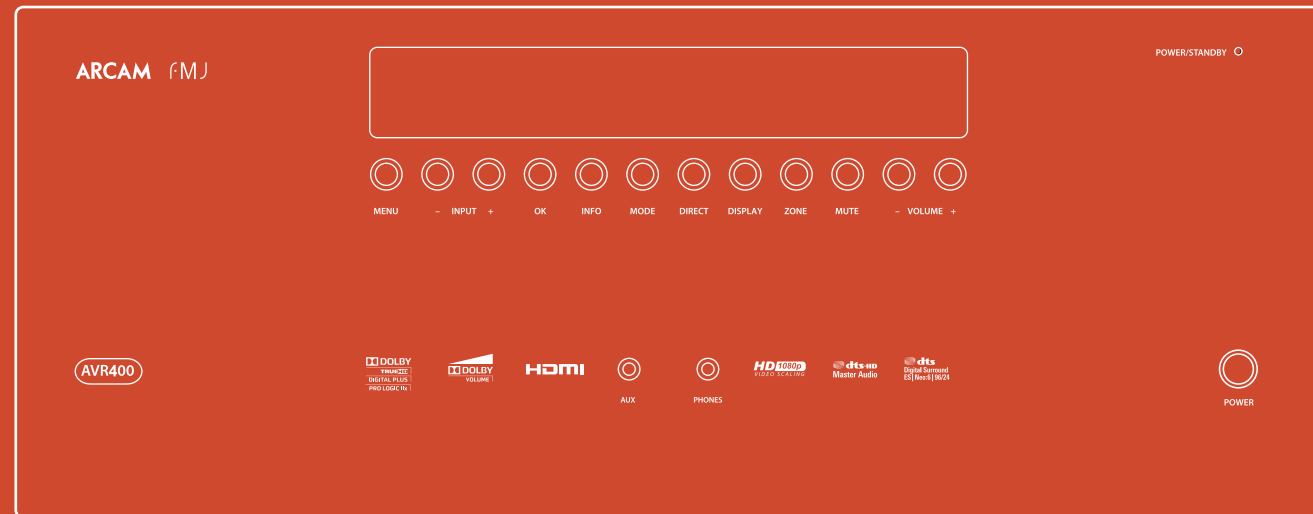

ARCAM

English

f·M·J AVR400

HANDBOOK AVR surround amplifier

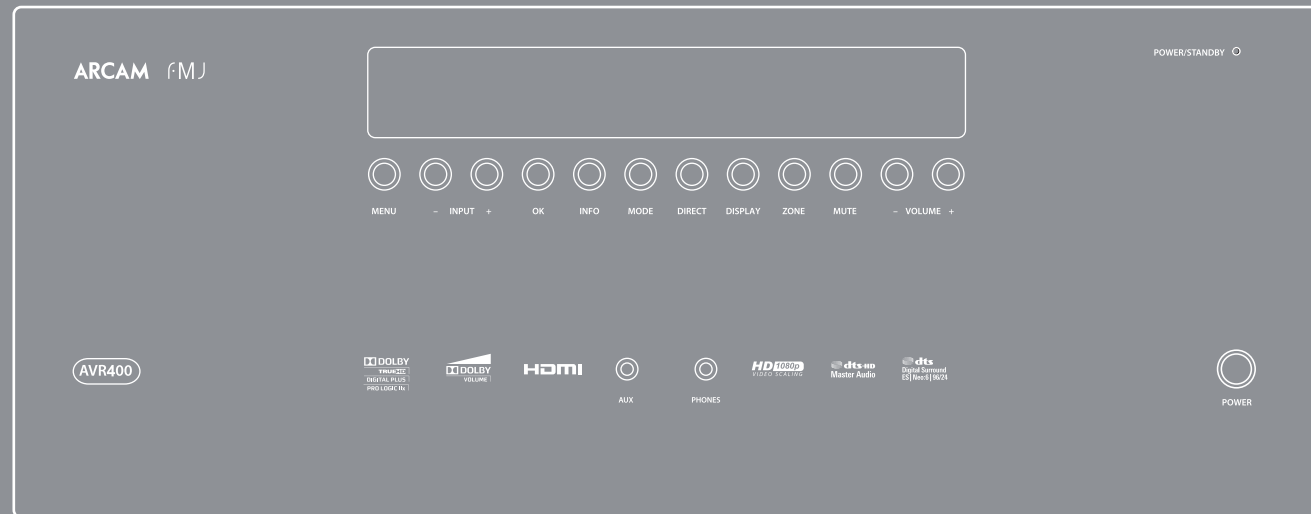



Important safety instructions

1. Read these instructions.
2. Keep these instructions.
3. Heed all warnings.
4. Follow all instructions.
5. Do not use this apparatus near water.
6. Clean only with a dry cloth.

Unplug the unit from the mains supply before cleaning. The case should normally only require a wipe with a soft, lint-free cloth. Do not use chemical solvents for cleaning. We do not advise the use of furniture cleaning sprays or polishes as they can cause permanent white marks.

7. Do not block any of the ventilation openings.

Install in accordance with the manufacturer's instructions.

8. Do not install near any heat sources such as radiators, heat registers, stoves, or other apparatus (including amplifiers) that produce heat.

9. Do not defeat the safety purpose of the polarized or grounding type plug.

A polarized plug has two blades with one wider than the other. A grounding type plug has two blades and a third grounding prong. The wide blade or the third prong is provided for your safety. When the provided plug does not fit into your outlet, consult an electrician for replacement of the obsolete outlet.

10. Protect the power cord from being walked on or pinched particularly at plugs, convenience

receptacles, and the point where they exit from the apparatus.

11. Only use the attachments/accessories specified by the manufacturer.

12. Use only with a cart, stand, tripod, bracket, or table specified by the manufacturer, or sold with the apparatus.



When a cart is used, use caution when moving the cart/apparatus combination to avoid injury from tip-over.

13. Unplug this apparatus during lightning storms or when unused for long periods of time.

14. Refer all servicing to qualified service personnel.

Servicing is required when the apparatus has been damaged in any way, such as power supply cord or plug is damaged, liquid has been spilled or objects have fallen into the apparatus, the apparatus has been exposed to rain or moisture, does not operate normally, or has been dropped.

15. Object or liquid entry

WARNING – Take care that objects do not fall and liquids are not spilled into the enclosure through any openings. The equipment shall not be exposed to dripping or splashing. Liquid-filled objects such as vases should not be placed on the equipment.

16. Service Instructions

CAUTION – These servicing instructions are for use by qualified service personnel only. To reduce the risk of

electric shock, do not perform any servicing other than that contained in the operating instructions unless you are qualified to do so.

17. Climate

The equipment has been designed for use in moderate climates and in domestic situations. Unplug this equipment during lightning storms to prevent possible damage from a strike or mains surge.

18. Power sources

Only connect the equipment to a power supply of the type described in the operating instructions or as marked on the equipment.

The primary method of isolating the equipment from the mains supply is to remove the mains plug. The equipment must be installed in a manner that makes disconnection possible.

19. Power-cord protection

Power supply cords should be routed so that they are not likely to be walked on or pinched by items placed upon or against them. Pay particular attention to the point where they exit from the equipment.

20. Power lines

Locate any outdoor antenna/aerial away from power lines.

21. Speaker connections

Any speakers must be connected to the AVR400 using class II wire (i.e. no connection to Earth should be made). Failure to observe this precaution may cause the unit to become damaged.



CAUTION: To reduce the risk of electric shock, do not remove cover (or back). No user serviceable parts inside. Refer servicing to qualified service personnel.

WARNING: To reduce the risk of fire or electric shock, do not expose this apparatus to rain or moisture.



The lightning flash with an arrowhead symbol, within an equilateral triangle, is intended to alert the user to the presence of uninsulated 'dangerous voltage' within the product's enclosure that may be of sufficient magnitude to constitute a risk of electric shock to persons.



The exclamation point within an equilateral triangle is intended to alert the user to the presence of important operating and maintenance (servicing) instructions in the literature accompanying the appliance.

CAUTION: In Canada and the USA, to prevent electric shock, match the wide blade of the plug to the wide slot in the socket and insert the plug fully into the socket.

Class II product



This equipment is a Class II or double insulated electrical appliance. It has been designed in such a way that it does not require a safety connection to electrical earth ('ground' in the U.S.).

22. Non-use periods

If the equipment is not being used for an extended period, we recommend that you unplug the power cord of the equipment from the outlet, to save power.

23. Abnormal smell

If an abnormal smell or smoke is detected from the equipment, turn the power off immediately and unplug the equipment from the wall outlet. Contact your dealer and do not reconnect the equipment.

CAUTIONS ON INSTALLATION

For proper heat dispersal, do not install this unit in a confined space, such as a bookcase or similar enclosure.

- More than 0.3 m (12 in.) is recommended.
- Do not place any other equipment on this unit.

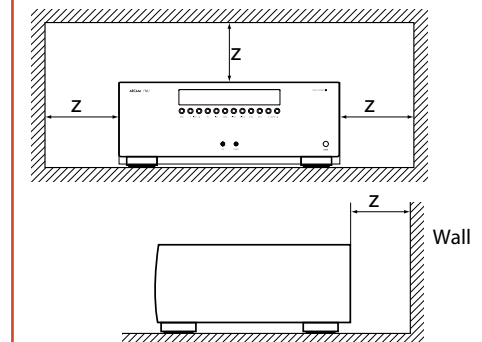

FCC INFORMATION (FOR US CUSTOMERS)**1. PRODUCT**

This product complies with Part 15 of the FCC Rules. Operation is subject to the following two conditions:

(1) This device may not cause harmful interference, and (2) this device must accept any interference received, including interference that may cause undesired operation.

2. IMPORTANT NOTICE:**DO NOT MODIFY THIS PRODUCT**

This product, when installed as indicated in the instructions contained in this manual, meets FCC requirements. Modification not expressly approved by ARCAM may void your authority, granted by the FCC, to use the product.

3. NOTE

This product has been tested and found to comply with the limits for a Class B digital device, pursuant to Part 15 of the FCC Rules. These limits are designed to provide reasonable protection against harmful interference in a residential installation.

This product generates, uses and can radiate radio frequency energy and, if not installed and used in accordance with the instructions, may cause harmful interference to radio communications. However, there is no guarantee that interference will not occur in a particular installation. If this product does cause harmful interference to radio or television reception, which can be determined by turning the product OFF and ON, the user is encouraged to try to correct the interference by one or more of the following measures:

- Reorient or relocate the receiving antenna.
- Increase the separation between the equipment and receiver.
- Connect the product into an outlet on a circuit different from that to which the receiver is connected.
- Consult the local retailer authorized to distribute this type of product or an experienced radio/TV technician for help.

**SAFETY INFORMATION
(FOR EUROPEAN CUSTOMERS)**

- Avoid high temperatures. Allow for sufficient heat dispersion when installed in a rack.
- Handle the power cord carefully. Hold the plug when unplugging the cord.
- Keep the unit free from moisture, water, and dust.
- Unplug the power cord when not using the unit for long periods of time.
- Do not obstruct the ventilation holes.
- Do not let foreign objects into the unit.
- Do not let insecticides, benzene, and thinner come in contact with the unit.
- Never disassemble or modify the unit in any way.
- Ventilation should not be impeded by covering the ventilation openings with items, such as newspapers, tablecloths or curtains.

- Naked flame sources such as lighted candles should not be placed on the unit.
- Observe and follow local regulations regarding battery disposal.
- Do not expose the unit to dripping or splashing fluids.
- Do not place objects filled with liquids, such as vases, on the unit.
- Do not handle the mains cord with wet hands.
- When the switch is in the OFF position, the equipment is not completely switched off from MAINS.
- The equipment shall be installed near the power supply so that the power supply is easily accessible.

A NOTE ABOUT RECYCLING:

This product's packaging materials are recyclable and can be reused. Please dispose of any materials in accordance with the local recycling regulations. When discarding the unit, comply with local rules or regulations.

Batteries should never be thrown away or incinerated but disposed of in accordance with the local regulations concerning battery disposal.

This product and the supplied accessories, excluding the batteries, constitute the applicable product according to the WEEE directive.

CORRECT DISPOSAL OF THIS PRODUCT

These markings indicate that this product should not be disposed with other household waste throughout the EU.

To prevent possible harm to the environment or human health from uncontrolled waste disposal and to conserve material resources, this product should be recycled responsibly.

To dispose of your product, please use your local return and collection systems or contact the retailer where the product was purchased.



Contents

Safety.....	E-2
Welcome	E-5
Before you begin.....	E-6
Rear Panel Connectors.....	E-9
Audio/Video Connections.....	E-10
Connection Guide.....	E-14
Radio Connectors	E-16
Other Connectors	E-17
Speakers	E-18
Operation	E-20
Front Panel Operation	E-22
Remote Control	E-23
Essential Setup	E-32
Auto Speaker Setup.....	E-33
Setup Menus	E-34
Decoding Modes.....	E-40
Dolby Volume.....	E-42
Tuner Operation.....	E-44
Network/USB Operation.....	E-45
Multi-Room Set Up	E-46
Multi-Room Connection Guide.....	E-47
Customising the CR102	E-48
Command Summary	E-51
Device Codes	E-51
Troubleshooting	E-52
Specifications.....	E-54
Product Guarantee	E-55
Device Code Tables.....	56

Thank you and congratulations on purchasing your Arcam FMJ AVR400 Receiver.

Arcam has been producing specialist audio products of remarkable quality for over three decades and the new AVR400 Receiver is the latest in a long line of award winning Hi-Fi. The design of the FMJ range draws upon all of Arcam's experience as one of the UK's most respected audio companies, to produce Arcam's best performing range of products yet – designed and built to give you years of viewing and listening enjoyment.

This handbook is intended to give you a detailed guide to using the AVR400 Receiver. It starts by giving advice on installation, moves on to describe how to use the product and finishes with additional information on the more advanced features. Use the contents list shown on this page to guide you to the section of interest.

We hope that your FMJ receiver will give you years of trouble-free operation. In the unlikely event of any fault, or if you simply require further information about Arcam products, our network of dealers will be happy to help you. Further information can also be found on the Arcam website at www.arcam.co.uk.

The FMJ development team

welcome

English

Professional Installation?

It may be that the AVR400 has been installed and set up as part of your Hi-Fi installation by a qualified Arcam dealer. In this case, you may wish to skip the sections of this handbook dealing with installation and setting up, and move directly to the sections dealing with using the unit. Use the Contents list to guide you to these sections.

DIY setup?

The AVR400 is a powerful and sophisticated piece of AV equipment. If you are setting the unit up yourself, it is recommended that you read this handbook thoroughly before beginning. For instance, correct speaker configuration and placement is a key to getting the most out of your AVR400 and making sure that all the elements of your system work in harmony.

before you
begin...

The AVR400 is a high-quality and high-performance home-cinema processor and amplifier built to Arcam's quality design and manufacturing standards. It combines digital processing with high-performance audio and video components to bring you an unrivalled home-entertainment centre.

The AVR400 allows switching and control of seven analogue and six digital audio sources in addition to internal AM, FM and DAB radio – as well as networked and USB audio sources – making it an ideal hub for both home-cinema and two-channel stereo systems.

Since many of these source components are also capable of generating video signals, the AVR400 includes broadcast-quality switching for HDMI, Composite, S-Video, RGB and Component video signals. BD-Audio and SACD can be connected via the multi-channel

input. Control of the AVR400 is either by front panel control buttons, IR remote control or RS232 port.

The CR102 remote control supplied with the AVR400 is an eight-device 'universal' learning remote control which is simple to use, and once set up is able to control a complete system. It can be programmed using its vast internal code library to control CD and BD players, PVRs, TVs and other devices.

The installation of the AVR400 in a listening room is an important process which requires care at every stage. For this reason, the installation information is very comprehensive and should be followed carefully to achieve an unrivalled level of performance.

The AVR400 receiver is designed to produce a level of performance that will truly bring music and movies to life.

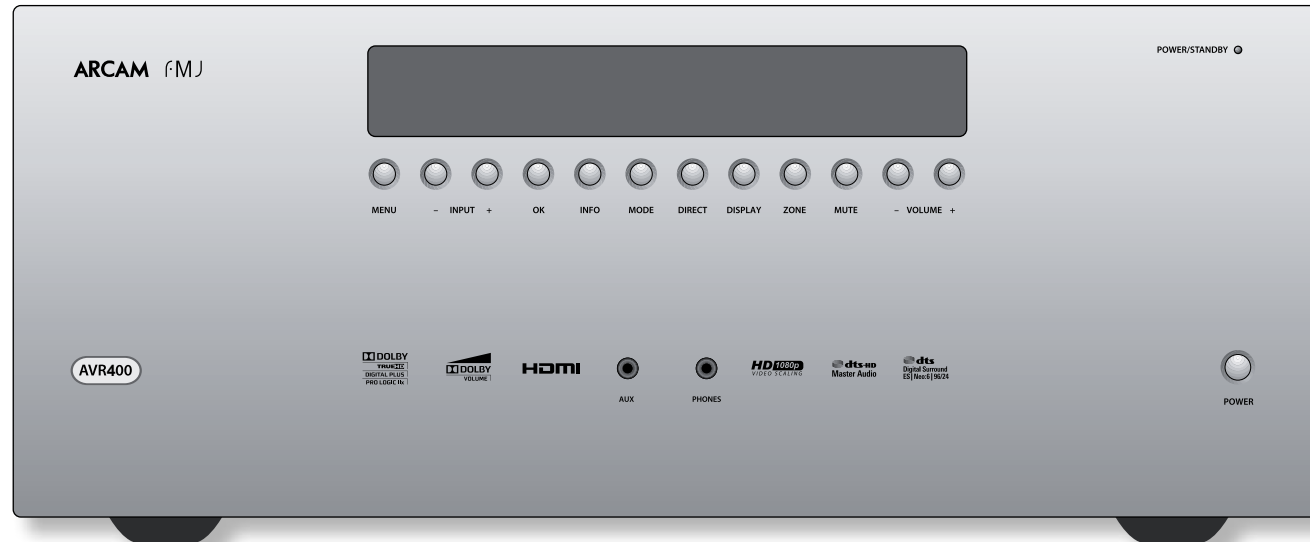

Placing the unit

- Place the unit on a level, firm surface, avoiding direct sunlight and sources of heat or damp.
- Do not place the AVR400 on top of a power amplifier or other source of heat.
- Do not place the amplifier in an enclosed space such as a bookcase or closed cabinet unless there is good provision for ventilation. The AVR400 will run warm during normal operation.
- Do not place any other component or item on top of the amplifier as this may obstruct airflow around the heat-sink, causing the amplifier to run hot. (The unit placed on top of the amplifier would become hot, too.)
- Make sure the remote-control receiver on the front panel display is unobstructed, otherwise this will impair the use of the remote-control. If line-of-sight is impractical, a remote-control repeater can be used with the rear panel connector (see page E-17).
- Do not place your record deck on top of this unit. Record decks are very sensitive to the noise generated by mains power supplies which will be heard as a background 'hum' if the record deck is too close.

Power

The amplifier is supplied with a moulded mains plug already fitted to the lead. Check that the plug supplied fits your supply – should you require a new mains lead, please contact your Arcam dealer.

If your mains supply voltage or mains plug is different, please contact your Arcam dealer immediately.

The AVR400 can be switched for operation between 220–240V (switch position 230V) and 110–120V (switch position 115V).

NOTE

Ensure that the AVR400 is switched off and the power lead removed before changing the position of the voltage range switch.

Push the IEC plug end of the power cable into the socket on the back of the amplifier, making sure that it is pushed in firmly. Plug the other end of the cable into your mains socket and, if necessary, switch the socket on.

The AVR400 can be turned on using the **POWER** switch on the front panel. While switched on, the front panel LED will glow green.

Standby power

The AVR400 can be switched into standby mode using the  button on the CR102 remote control. While in standby mode the front panel LED will glow red and power consumption is less than 0.5 Watts.

While in Standby mode, it may be possible to hear a slight residual hum coming from the mains transformer inside the amplifier. This is perfectly normal. However, if the unit is to be left unused for an extended period, we recommend that you disconnect it from the mains supply to save power.

Interconnect cables

We recommend the use of high-quality screened cables that are designed for the particular application. Other cables will have different impedance characteristics that will degrade the performance of your system (for example, do not use cabling intended for video use to carry audio signals). All cables should be kept as short as is practically possible.

It is good practice when connecting your equipment to make sure that the mains power-supply cabling is kept as far away as possible from your audio cables. Failure to do so may result in unwanted noise in the audio signals.

For information on speaker cabling, please refer to the 'Speakers' section, beginning on page E-18.

Radio interference

The AVR400 is an audio device containing microprocessors and other digital electronics. It has been designed to very high standards of electromagnetic compatibility.

This is a Class A product. In a domestic environment this product may cause radio interference, in which case the user may be required to take adequate measures.





If the AVR400 causes interference to radio or television reception (which can be determined by switching the AVR400 off and on), the following measures should be taken:

- Re-orient the receiving antenna or route the antenna cable of the affected receiver as far as possible from AVR400 and its cabling.
- Relocate the receiver with respect to the AVR400.
- Connect the affected device and the AVR400 to different mains outlets.

If the problem persists, please contact your Arcam dealer.

Trademark acknowledgements

Arcam is a registered trademark of A & R Cambridge Ltd.

	<p>Dolby Volume</p> <p>Manufactured under license from Dolby Laboratories. Dolby and the double-D symbol are trademarks of Dolby Laboratories.</p>
	<p>Dolby TrueHD, Digital, Digital Plus, PL IIx</p> <p>Manufactured under license from Dolby Laboratories. Dolby, Pro Logic, and the double-D symbol are trademarks of Dolby Laboratories.</p>
	<p>DTS-HD Master Audio</p> <p>Manufactured under license under U.S. Patent #s: 5,451,942; 5,956,674; 5,974,380; 5,978,762; 6,226,616; 6,487,535; 7,212,872; 7,333,929; 7,392,195; 7,272,567 & other U.S. and worldwide patents issued & pending. DTS and the Symbol are registered trademarks, & DTS-HD, DTS-HD Master Audio, and the DTS logos are trademarks of DTS, Inc. Product includes software. © DTS, Inc. All Rights Reserved.</p> <p>DTS-HD High Resolution Audio</p> <p>Manufactured under license under U.S. Patent #s: 5,451,942; 5,956,674; 5,974,380; 5,978,762; 6,226,616; 6,487,535; 7,212,872; 7,333,929 & other U.S. and worldwide patents issued & pending. DTS and the Symbol are registered trademarks, & DTS-HD, DTS-HD High Resolution Audio and the DTS logos are trademarks of DTS, Inc. Product includes software. © DTS, Inc. All Rights Reserved.</p>
	<p>DTS Digital Surround ES Neo:6 96/24</p> <p>Manufactured under license under U.S. Patent #s: 5,451,942; 5,956,674; 5,974,380; 5,978,762; 6,226,616; 6,487,535; 7,003,467; 7,212,872 & other U.S. and worldwide patents issued & pending. DTS, the Symbol, ES, and Neo:6 are registered trademarks & DTS Digital Surround, DTS 96/24 and the DTS logos are trademarks of DTS, Inc. Product includes software. © DTS, Inc. All Rights Reserved.</p>
	<p>AAC/AAC Plus</p> <p>aacPlus is a trademark of Coding Technologies. See www.codingtechnologies.com for more information.</p>

FLAC	<p>FLAC Decoder Copyright © 2000, 2001, 2002, 2003, 2004, 2005, 2006, 2007, 2008 Josh Coalson</p> <p>Redistribution and use in source and binary forms, with or without modification, are permitted provided that the following conditions are met:</p> <ul style="list-style-type: none"> - Redistributions of source code must retain the above copyright notice, this list of conditions and the following disclaimer. - Redistributions in binary form must reproduce the above copyright notice, this list of conditions and the following disclaimer in the documentation and/or other materials provided with the distribution. - Neither the name of the Xiph.org Foundation nor the names of its contributors may be used to endorse or promote products derived from this software without specific prior written permission. <p>THIS SOFTWARE IS PROVIDED BY THE COPYRIGHT HOLDERS AND CONTRIBUTORS "AS IS" AND ANY EXPRESS OR IMPLIED WARRANTIES, INCLUDING, BUT NOT LIMITED TO, THE IMPLIED WARRANTIES OF MERCHANTABILITY AND FITNESS FOR A PARTICULAR PURPOSE ARE DISCLAIMED. IN NO EVENT SHALL THE FOUNDATION OR CONTRIBUTORS BE LIABLE FOR ANY DIRECT, INDIRECT, INCIDENTAL, SPECIAL, EXEMPLARY, OR CONSEQUENTIAL DAMAGES (INCLUDING, BUT NOT LIMITED TO, PROCUREMENT OF SUBSTITUTE GOODS OR SERVICES; LOSS OF USE, DATA, OR PROFITS; OR BUSINESS INTERRUPTION) HOWEVER CAUSED AND ON ANY THEORY OF LIABILITY, WHETHER IN CONTRACT, STRICT LIABILITY, OR TORT (INCLUDING NEGLIGENCE OR OTHERWISE) ARISING IN ANY WAY OUT OF THE USE OF THIS SOFTWARE, EVEN IF ADVISED OF THE POSSIBILITY OF SUCH DAMAGE.</p>
vTuner	<p>This product is protected by certain intellectual property rights of NEMS and BridgeCo. Use or distribution of such technology outside of this product is prohibited without a license from NEMS and BridgeCo or an authorized subsidiary.</p>
MP3	<p>MPEG Layer-3 audio decoding technology licensed from Fraunhofer IIS and Thomson multimedia</p>
iPod	<p>iPod is a trademark of Apple Inc., registered in the US and other countries.</p>

	<p>HDMI, the HDMI logo and High-Definition Multimedia Interface are trademarks or registered trademarks of HDMI Licensing LLC.</p>
ROVI	<p>This item incorporates copy protection technology that is protected by U.S. patents and other intellectual property rights of Rovi Corporation. Reverse engineering and disassembly are prohibited.</p>

rear panel connectors

Digital connectors

Optical and electrical digital audio connectors, see page E-11.

HDMI

For information, see page E-10.

Video connectors

Component, S-Video and Composite connectors, see page E-11.

Zone 2 connection, see page E-11.

Audio connectors

Two-channel and multi-channel, see page E-12.

Preamplifier output

See page E-12

Aerials, control and communication

FM/AM/DAB radio, rLead/irDock, RS232, Network/USB, IR and trigger connectors, see page E-16, page E-17.

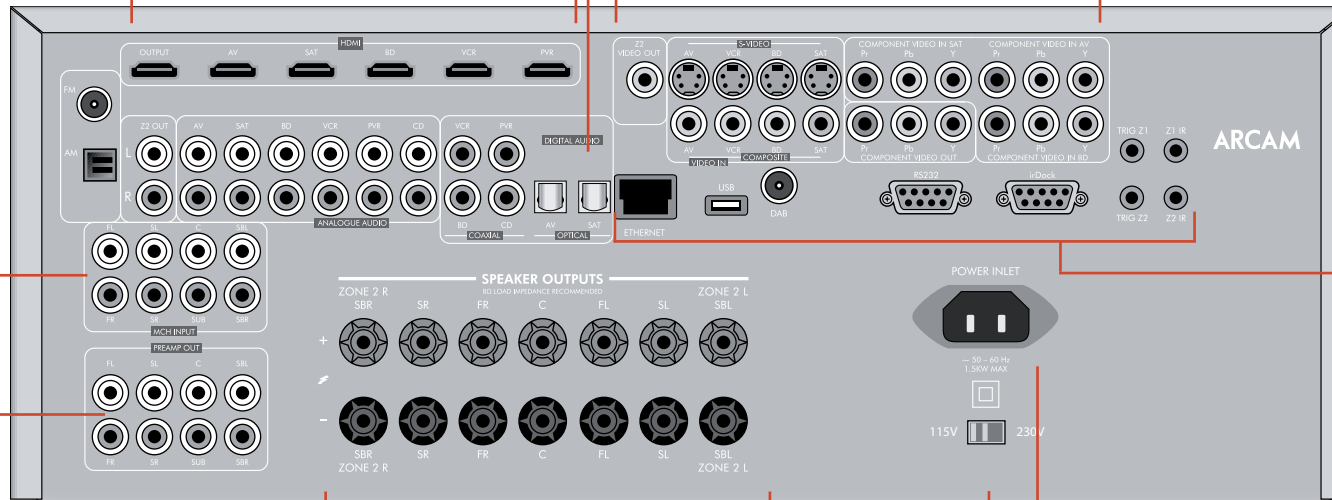

Speaker connectors

For information, see page E-19.

Power inlet

Connect the correct mains cable here

Voltage select

Ensure the voltage selected matches your local power supply

NOTE

Please read the 'Placing the unit', 'Power' and 'Interconnect cables' sections on page E-7 before connecting up your AVR400 integrated amplifier!

audio/video connections

Before connecting your AVR400 to your source components and speakers, please read through the next few pages which will explain all the input and output connectivity that is available. The 'Speakers' section explains how to connect up your speakers to avoid damage to the amplifier and how to arrange your speakers for best performance.

General

The inputs are named to make it easier to reference connected devices (e.g. 'BD' or 'VCR'). They all have the same input circuit, so there is no reason why you should not connect a different device to any of the inputs. For example, if you had two BD players and the AV input was not being used, then the second BD player could be connected to the AV input.

When connecting a video source, its audio must be connected to the corresponding sockets. For example, if you had a satellite decoder plugged into a SAT video input, the audio must be connected to the SAT audio inputs!

The hierarchy for video connections for best quality is as follows:

- HDMI
- Component/RGB
- S-Video
- Composite.

For any video source to be available in Zone 2 you must have a Composite connection between AVR400 and the source.

Making connections

- Wherever possible, connect both the analogue and digital outputs of digital sources. This enables use of a digital input for the main zone and the corresponding analogue input for the Zone 2 output.
- Take care to place cables as far from any power supply cabling as is practicable, to reduce hum and other noise problems.

NOTE:

For each input, you must set the "Video Source" and "Audio Source" settings according to the connection type. (see "Input Config." on page E-35)

Important notes about Component/RGB video inputs and outputs

- When you connect your devices to these connectors, take care to follow the letter/colour coding for each input. No damage will occur but incorrectly coloured or unstable pictures will result.
- The Component video inputs have sufficient bandwidth for NTSC (525/60) or PAL (625/50) video and HDTV video signals.



HDMI connectors

AV, SAT, BD, VCR, PVR

Connect the HDMI video outputs of your source equipment to these corresponding HDMI inputs.

OUTPUT

Connect this output to the HDMI video input of your display device. This output is compatible with the HDMI 1.4 Audio Return Channel (ARC). If you have a supported television then sound from the television's internal tuner (e.g. Freeview, Freesat, DVB-T) will be available using the AVR400's "Display" input.

Component/RGB video connectors

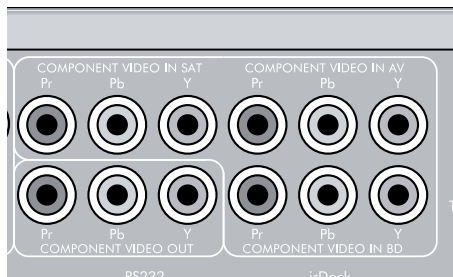

These inputs are suitable for connection to source devices which output Component (YUV or YPbPr) or RGB high quality analogue video signals. These signals are usually available from BD players, set-top boxes or games consoles.

If you are connecting up to an RGB source you may also need to connect the source's Composite output to the AVR400 Composite input to act as a video sync ('RGB + Sync' format). The Composite signal should be on the same named input as the RGB signals. The AVR400 is also compatible with 'Sync on Green' or 'RGsB' signals.

RGB video outputs on source equipment are often on SCART connectors. You will need to use a SCART to 'RGB+Sync on phono' breakout cable, available from your Arcam dealer.

NOTE

When setting up the AVR400 menus (later in this manual), you will need to select whether the three-wire high quality video input is Component ('Normal'), 'RGsB' or 'RGB + Sync' for each input. This is done on the 'Component Mode' line in the Input Config menu. Failure to do this can result in a green looking picture or a picture that is unstable.

COMPONENT VIDEO IN SAT, AV, BD

Connect the Component video outputs of your source equipment to these inputs.

COMPONENT VIDEO OUT

Connect this output to the Component video input of your display device.

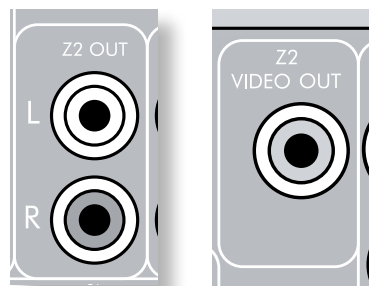

Zone 2 connectors

The Z2 out analogue audio connector can be used to connect the stereo audio output of the AVR400 to an amplifier located in a second room. Connect the analogue video output to your Zone 2 display equipment. See 'Multi-room Setup' on E-46 for information.

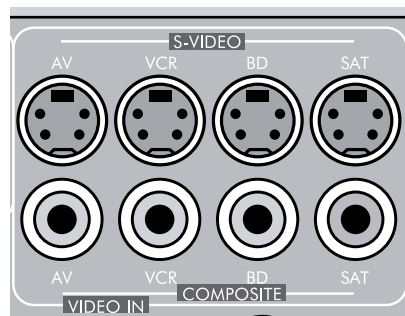

S-Video and Composite connectors

AV, VCR, BD, SAT

Connect these inputs to the S-Video and Composite outputs of your available source equipment.

NOTE

Analogue RGB video output is not available from the AVR400. The analogue three-wire high quality video output is always configured as Component video.

Digital audio connectors



VCR, PVR, BD, CD, AV, SAT

Connect these inputs to the digital outputs of your available source equipment.

MCH input

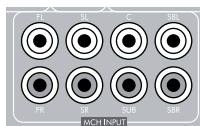

This multi-channel analogue audio input can be connected to a source device which outputs surround sound on its analogue outputs. Such devices typically include DVD-Audio

and SACD players. This input does not pass through any of the audio processing in the AVR400, therefore functions such as speaker size and distance from the listening position should be copied from the AVR400 Setup menus into the Setup menus of your multi-channel source. Note however that speaker level trims *are* applied to the MCH input on the AVR400. Therefore speaker level trim settings on multichannel source equipment should be left unset at zero.

Analogue pre-amplifier outputs

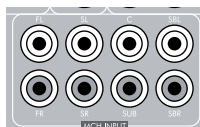

All pre-amplifier analogue outputs are buffered, have a low output impedance, are at line level and follow the Zone 1 volume control setting. They are able to drive

long cables or several inputs in parallel if required.

For more information on connecting speakers or additional power amplifiers, see page E-18 and E-19.

Analogue audio inputs



AV, SAT, BD, VCR, PVR, CD

Connect the left and right inputs to the left and right outputs of your source equipment.

Front panel AUX input

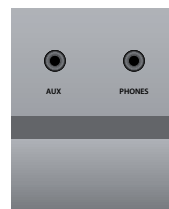

The front panel **AUX** input can be used as an analogue or optical digital input.

For analogue sources, use a stereo 3.5mm lead; for digital sources use a 3.5mm optical lead. The front input is also used for the auto-setup microphone input.

Front panel PHONES socket

This socket accepts headphones with an impedance rating between 32 Ω and 600 Ω , fitted with a 3.5mm stereo jack plug. The headphone socket is always active, except when AVR400 is muted.

When the headphone jack is inserted, the speaker outputs and analogue pre-amplifier outputs are automatically muted.

Connection guide

Blu-ray Disc (BD) / DVD player

The diagram shows how to make audio and video connections from a typical BD/DVD player.

The preferred video hook-up, in order of preference is:

- use the HDMI connector (if HDMI output is provided by the player), otherwise connect the three Component or four RGB+Sync video connectors.
- use the S-Video connection if HDMI or Component /RGB+Sync outputs are not provided by your player.
- use the Composite connection if HDMI, Component/RGB+Sync or S-Video are not provided by your player.

In each case, connect the video inputs labelled **BD** on the AVR400.

The preferred audio hook-up is using the coaxial digital connector (usually marked **DIGITAL AUDIO OUT**), in addition to the coaxial analogue outputs for left and right channels.

In each case, use the audio inputs labelled **BD** on the AVR400.

Satellite receiver

A satellite receiver is connected in the same way as a BD player, with the same order of preference according to the outputs provided by the satellite receiver.

In each case, use the inputs labelled **SAT** on the AVR400. Note that digital audio input from a satellite receiver sometimes requires a coaxial/TOSLINK (digital connector) interconnect cable, as some satellite receivers do not implement audio over HDMI properly or at all.

CD player

Connect the digital audio output (if provided by the CD player) to the digital **CD** input of the AVR400, using a high quality coaxial interconnect cable.

Connect the right and left analogue audio outputs of the CD player to the analogue **CD** inputs of the AVR400, using a pair of high quality coaxial interconnect cables.

NOTE:

For each input, you must set the “**Audio Source**” setting according to the connection type. (see “Input Config.” on page E-35)

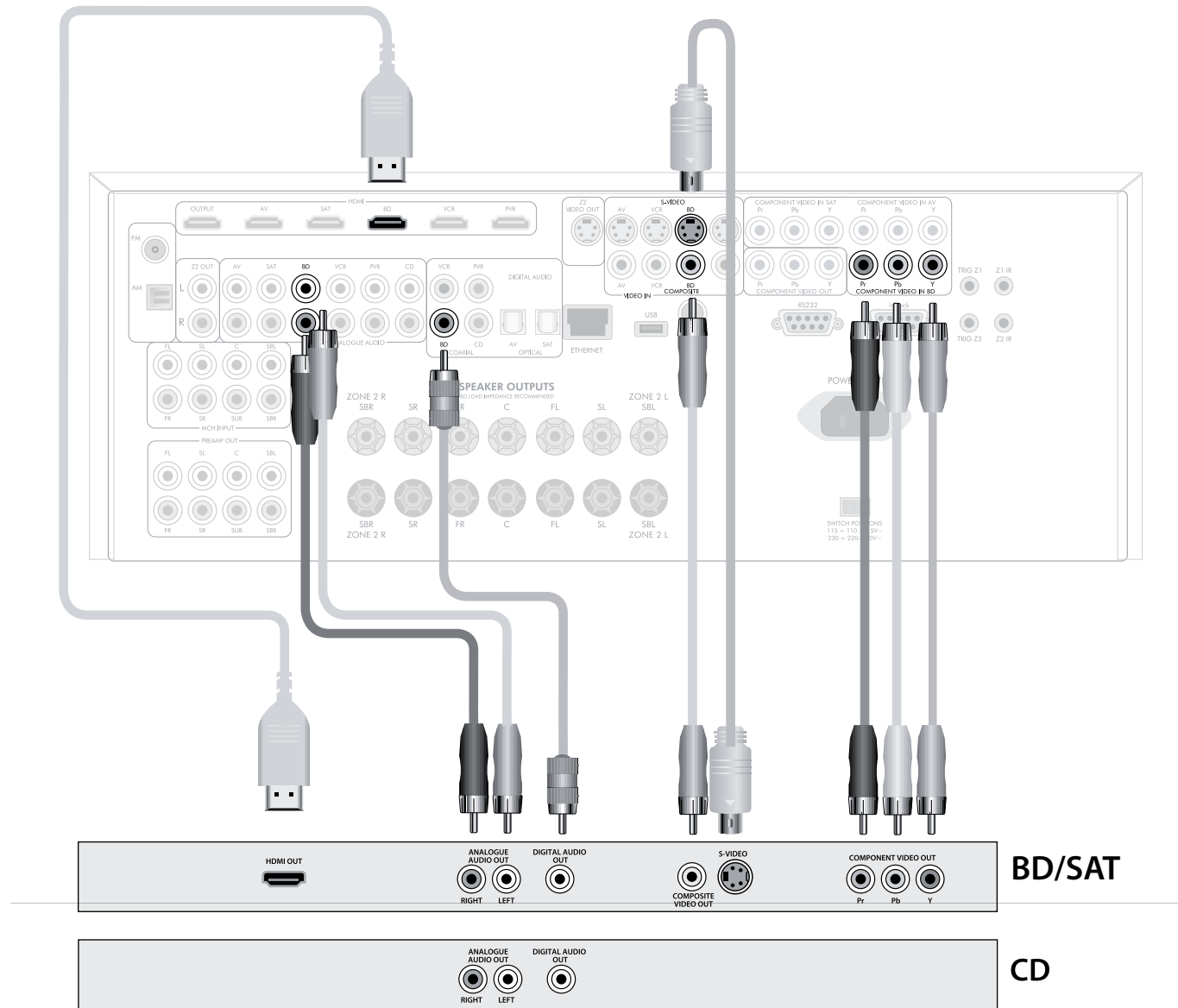

Connecting an iPod using the Arcam irDock

The combination of the AVR400 and Arcam's optional irDock or rLead accessory provides a great platform for your iPod.

Connect the irDock as shown, power on the irDock, slot in your iPod and select iPod as the source. Note that the default input is VCR but this can be changed in the General Setup menu.

Navigating through music and podcasts on your iPod is simple using the CR102 remote, with text appearing on the AVR400 display.

More information is given in the irDock quick start guide (or rLead quick start guide) supplied with these accessory units.

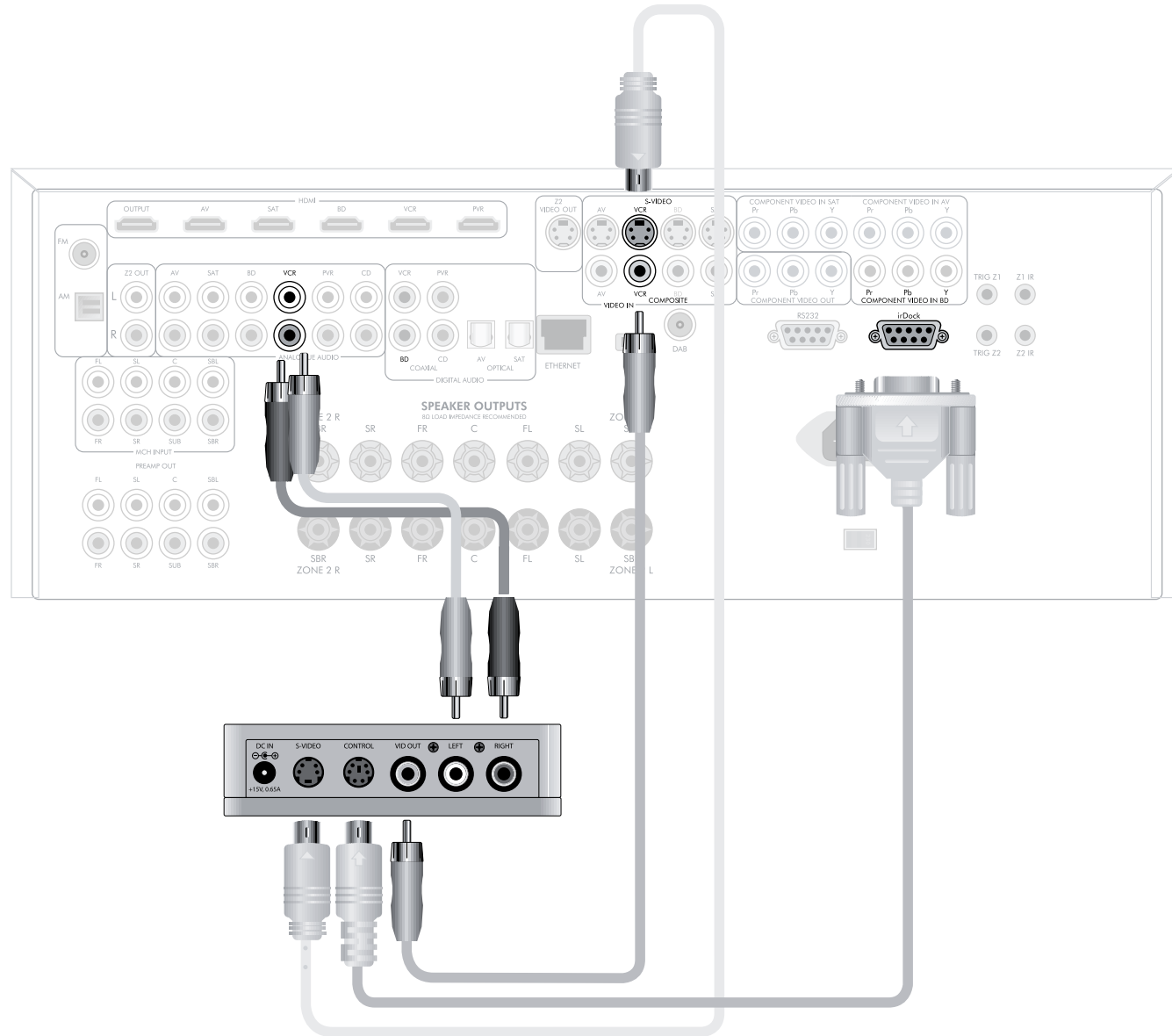

radio connectors

Aerial connectors

The AVR400 is fitted with an AM/FM receiver module and a DAB receiver, depending on the region where it was sold. The type of aerial you need depends on your listening preferences and the local conditions.

Your AVR400 is capable of superb radio reception, but only if it is receiving a good quality transmission signal.

Try the aerials supplied with your unit. If you are in a medium to strong signal area, these should be adequate for good reception. In areas with poor signal strength, you may require a roof or loft mounted aerial.

Contact your local Arcam dealer or aerial installation experts for advice about local reception conditions.

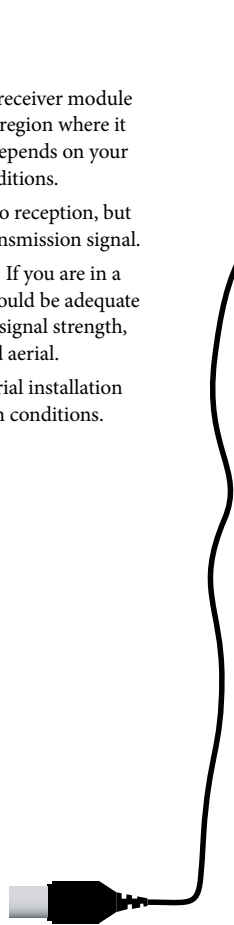

DAB (where fitted)

In strong signal areas, the DAB 'T' wire aerial supplied can be used with reasonable results. Mount the aerial as high up as possible on a wall.

In the UK the 'T'-elements need to be positioned vertically for DAB reception since broadcasts are vertically polarised. In other localities, check with your Arcam dealer or try both horizontal and vertical positions for best reception.

Try each usable wall of the room to see which gives best reception and use tacks or adhesive tape to secure the aerial in a 'T' shape, but note that no tacks should come into contact with the internal wire of the aerial.

When installed and receiving DAB, check the signal strength by pressing the front panel or remote control's **INFO** button until the signal quality indicator is displayed.

In weak signal areas, a high-gain, externally-mounted or roof-mounted aerial is desirable in order to receive the highest number of services.

In Band III transmission areas (such as the UK), use a multi-element Yagi aerial with the elements mounted vertically, as the transmissions are vertically polarised. If you are close to more than one transmitter, use an omnidirectional or folded dipole aerial.

If the DAB services in your area are transmitted on L-band, then ask your dealer for advice for the best aerial to use.



FM

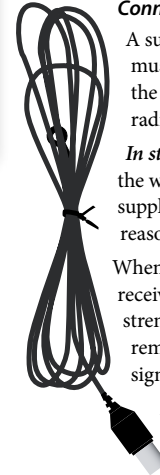

Connecting an aerial

A suitable FM aerial must be connected to the AVR400 before FM radio can be received.

In strong signal areas, the wire FM aerial supplied can be used with reasonable results.

When installed and receiving FM radio, check the signal strength by pressing the front panel or remote control's **INFO** button until the signal indicator is displayed.

In weak signal areas, or for optimal FM radio reception, a roof- or loft-mounted aerial is advised as this will give superior reception.

In some areas, cable radio may be available or, in an apartment building, a distributed aerial system may be installed. In either of these cases you should have sockets in your home marked **FM** or **VHF** (do not use those marked **TV**); these should be connected to the **FM** coaxial connector on the rear of the AVR400.

AM

Connecting an aerial

An AM aerial is required to receive AM/medium wave radio signals, so a simple loop aerial is supplied with the AVR400. Follow the assembly instructions in the diagram below.

Make sure that the aerial is positioned well away from the AVR400 itself, TVs, computers and other sources of RF 'interference'. Rotate the aerial to discover which position gives the best reception.



3. Connect the lead wires to the AM socket at the rear of the AVR400 (the wires are not polarised). Rotate the aerial's stand until you obtain the best reception.

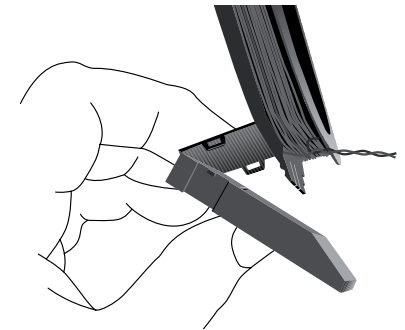

2. Push the tab into the open slot in the base of the stand. Press until the tab clicks home.

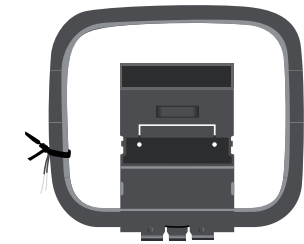

1. Release the tie-wrap and unwind the twisted lead. Fold the plastic stand forward through the loop frame.

other connectors

Data connectors



rLead/irDock

For use with an Arcam rLead or irDock accessory. See page E-15 and the accessory documentation for details.

RS232 serial connector

Use with control devices having an RS232 serial port (for example, Crestron and AMX touch screen controllers).

Network connector

This section deals with installation of the unit into an existing home network. For information on how to use the AVR400's network features, the USB socket, and for a list of supported file types, refer to page E-45.

Networking is a large subject and only the briefest guidelines are presented in this handbook. Please contact your Arcam dealer or specialist installer for more information about introducing the AVR400 into your computer network.

Ethernet

If an Ethernet cable is connected, the AVR400 will automatically attempt to connect to your network. You should use CAT5 cable plugged into the RJ45 socket labelled **ETHERNET** on the rear panel.

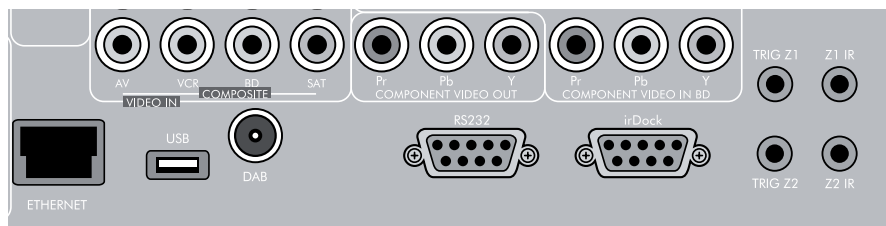

If your network uses static IP addressing rather than DHCP, you will need to provide IP address, gateway, DNS and proxy information. See page E-39 for information on setting up the network.

USB connector



The AVR400 can play files stored on a USB mass storage device, typically a pen drive, but any USB device that complies with the 'mass storage device' class is compatible.

The AVR400 only supports the direct connection of USB devices and will not support devices connected through a hub. If regular access to the **USB** socket is required, you may find it convenient to use a USB extension lead.

See page E-45 for details of supported file types.

Trigger connectors

The trigger connectors (**TRIG Z1** and **TRIG Z2**) provide an electrical signal whenever the AVR400 is switched on and the relevant zone enabled.

The trigger signal can be used to switch on and off compatible pieces of home entertainment equipment, for example, you could set up a trigger to turn on your television and BD player whenever the AVR400 was switched on.

There are two trigger output sockets on the AVR400, each capable of outputting a 12V, 70mA switching signal. The socket is designed for mono 3.5mm jacks: tip is the trigger output, sleeve is ground.

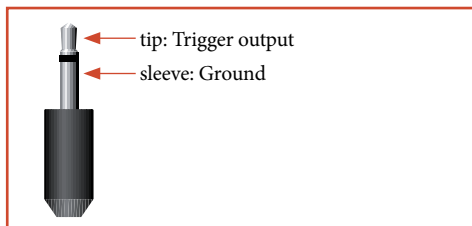

TRIG Z1

Use for remotely turning on and off power amps or source equipment for Zone 1. On = 12V, Off = 0V.

TRIG Z2

Use for remotely turning on and off power amps or source equipment for Zone 2. On = 12V, Off = 0V.

Infra-red (IR) connectors

The infra-red inputs (**Z1 IR** and **Z2 IR**) allow the connection of external IR receivers, either when the AVR400 front panel IR receiver is fully or partially obstructed or to allow the use of a remote control in Zone 2.

There are two IR inputs on the AVR400, each designed for stereo or mono 3.5mm jacks. Tip is the modulated signal, sleeve is ground.

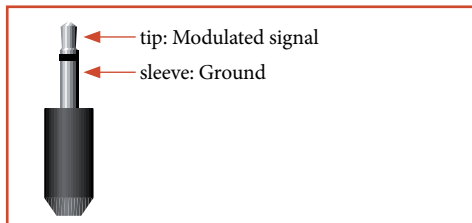

NOTE

Sockets referring to 'Z2' relate to connections used in multi-room installation. For more information on these connectors, see page E-46.

Z1 IR

This input is intended for use with a local IR receiver when the front panel of the AVR400 is blocked.

Connecting an IR receiver to **Z1 IR** will disable front panel IR receiver to prevent problems with multiple commands if the front panel IR receiver is only partially obstructed.

Z2 IR

This input is intended for use with an IR receiver in Zone 2 to allow remote control of AVR400 from a second room.

A supplier of infra-red receivers and emitter accessories and systems is Xantech. See www.xantech.com for more information, or ask your Arcam dealer.

NOTE

The IR inputs on the AVR400 are designed for modulated signals. If the external IR receiver demodulates the IR signal, it will not work. Also the AVR400 does not provide power for external receivers on the IR jack, therefore an external power source will be required.

speakers

The AVR400 allows you to connect up to seven speakers and an active subwoofer in the main system. The output channels correspond to speakers installed in the front left, centre, front right, surround left, surround right, surround back left, surround back right and an active subwoofer.

The configuration and placement of your speakers is very important. All speakers, with the exception of the subwoofer, should be arranged around your normal viewing/listening position. The subwoofer should be placed in a position which gives an even frequency response in all listening positions. Incorrect placement leads to bass boom in some areas. Often the only way to find a good position for your subwoofer is by experimentation. A good place to start experimenting is close to a wall but at least 1m away from any corners. You can also consult your subwoofer handbook for placement suggestions.

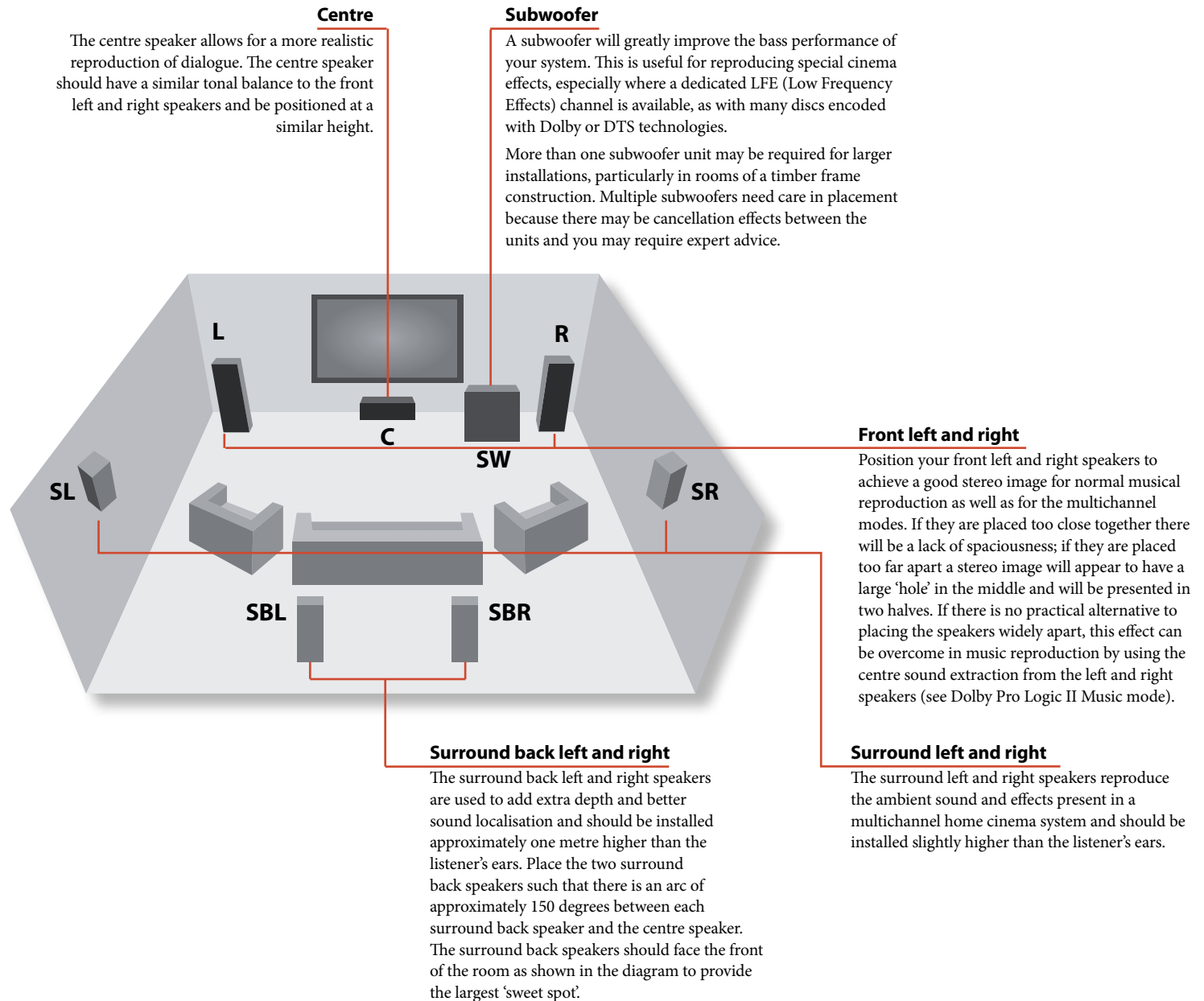

Connecting speakers

To connect each of the speakers, unscrew the corresponding terminals on the back of the AVR400, insert the speaker wires through the hole in each post and screw the terminals back up. Make sure that the red (positive/+) terminal of the speaker is connected to the red (positive/+) terminal on the back panel, and the black (negative/-) terminal of the speaker is connected to the black (negative/-) terminal on the back panel.

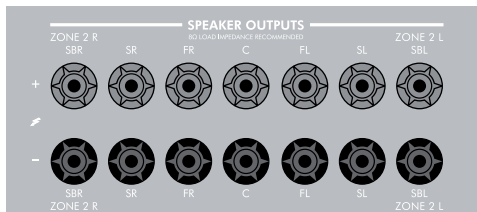

It is important that no stray strands of wire from these connections are allowed to touch another cable or the product casing. Failure to ensure this can cause a short circuit and damage your AVR400.

Do not over-tighten the loudspeaker terminals, or use a wrench, pliers, etc., as this could damage the terminals and this would not be covered under the product's warranty.

Speaker cables

The speakers should be connected to the amplifier using good-quality, high-purity, low impedance copper cables. Cheap speaker cables should be avoided – they are a false economy and can significantly degrade the sound quality.

The cable runs to the speakers should be as short as practicable. Connections to the speaker terminals should always be finger tight, whether using bare wires or spade connectors.

Bi-Amping the Front Left & Right speakers

Bi-amping is the use of two amplifier channels per speaker. Bi-amping can provide better sound quality than conventional single wiring. If you do not have Surround Back speakers (i.e. you have a 5.1 surround system, not a 7.1 system) then you can use the spare Surround Back speaker outputs to bi-amplify the front left and right speakers, if your speakers support bi-amping. The spare channels can alternatively be used to power stereo speakers in another room (Zone 2).

Speakers that support bi-amping have two sets of +/- terminals per speaker, usually linked together by metal strips. These metal strips **MUST** be removed when bi-amping; failure to remove them will result in damage to the amplifier that is not covered under warranty.

To bi-amp the front left and right speakers, remove the metal strips from the speaker terminals. Connect the woofer or LF terminals to the FL and FR terminals on the AVR400. Connect the tweeter or HF terminals to the SBL and SBR terminals on the AVR400. Finally, navigate to the Setup Menu "Spkr Types" and set the 'Use Channels 6+7 for' menu option to "BiAmp L+R" — see page E-32.

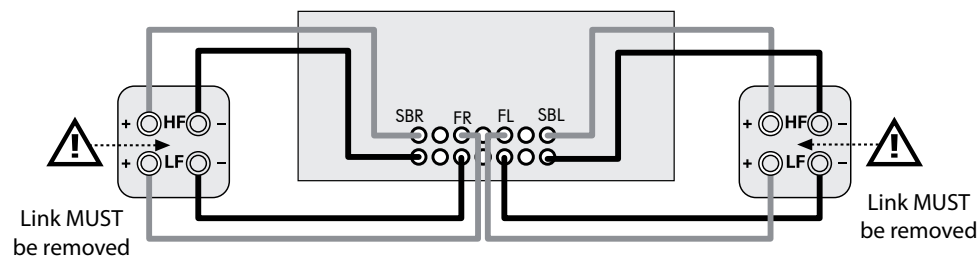

Connecting subwoofers

The AVR400 also allows an active subwoofer to be connected to the SUB output.

See your subwoofer handbook for the correct setting up and connection for your particular subwoofer.

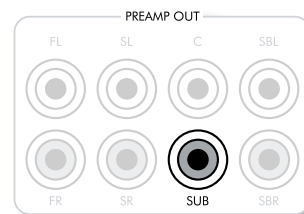

Using external power amplifiers

The internal power amplifier of the AVR400 can be supplemented or replaced with external power amplification. Connect the PREAMP OUT sockets to your power amplifier inputs:

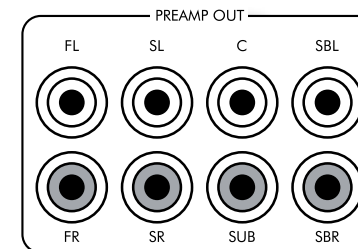

FL, FR, C

Connect these to the equivalent (Right, Left and Centre) front channels of your power amplifier.

SUB

Subwoofer output. Connect this to the input of your active subwoofer, if present.

SR, SL

Surround Right and Surround Left outputs. Connect these to the Surround Right and Left power amplifier inputs.

SBR, SBL

Surround Back Right and Surround Back Left outputs (only used in 7.1 channel systems). Connect these to the Surround Back Right and Surround Back Left power amplifier inputs.

All pre-amplifier analogue outputs are buffered, have a low output impedance and are at line level. They are able to drive long cables or several inputs in parallel if required.

operation

Operating your AVR400

For information display we recommend you use the OSD (On-Screen Display) on your display device whenever possible.

Switching on

Press the front panel power button in. The power LED will glow green, the front display shows the word 'PFCFM'. When initialisation is complete, the display shows the volume setting and the name of the selected input.

Please wait until the unit has finished initialising before operating the AVR400. It is recommended that if the unit is switched off, you should wait at least 10 seconds before switching the unit back on.

Standby

The AVR400 has a standby mode which can be entered by pressing **STANDBY** on the remote control. When in standby mode, the display is blank and the **POWER** LED glows red.

If the unit is to be left unused for an extended period, we recommend that you disconnect it from the mains supply to save power.

To switch on from standby

Press the **STANDBY** button on the remote control or any key on the front panel (other than the power button).

Front panel display

The AVR400 is ready for use after about four seconds.



The display window shows the currently selected source and the last selected information view setting (this information line can be changed using the **INFO** button).

The current volume setting for Zone 1 (37.0dB in the above example) is displayed on the front panel. The volume setting for Zone 2 is displayed temporarily whenever it is adjusted.

Selecting a source

To select a particular source, press the **-INPUT** or **INPUT +** buttons until that source is shown on the front panel display, or (if available) press the corresponding source button on the remote. The following sources are available:

CD	Compact Disc player input
BD	Blu-ray Disc player input
AV	Audio-Visual input
SAT	Satellite receiver input
PVR	Personal Video Recorder input
VCR	Video Cassette Recorder input
IPOD	Requires an iPod® and Arcam irDock or rLead .
AM	Internal tuner input
FM	Internal tuner input
DAB*	Internal tuner input
NET	Internal (Ethernet) and external USB solid-state device (e.g. pen drive) input.
MCH	Selects MCH (multi-channel) analogue input
AUX	Auxiliary (front panel) input
DISPLAY	The Audio Return Channel (ARC) from an HDMI 1.4-compliant display. Use this with an HDMI 1.4-compliant television using internal TV tuners.

*These sources are market dependent and may not be available on your AVR400

Most audio inputs have both analogue and digital connections. You must specify the type of connection used for each input using the “**Audio Source**” option in the “Input Config.” menu, see page E-35. Note that an incorrect setting will result in no sound — the default is HDMI audio. If you are not using HDMI audio then this setting must be changed.

The processing mode and Stereo Direct functions are remembered and recalled for each individual input.

The **MCH** input is intended for direct analogue pass-through of DVD-Audio or SACD sources. Apart from volume control and level trim, no processing modes are possible on this input, including AVR400 bass management and delays. Please set bass management, speaker size and speaker delays in the source player. You

can copy the distances and relative speaker levels from the Setup menus in the AVR400.

Stereo Direct

To listen to a pure analogue stereo input, press the **DIRECT** button. The Stereo Direct mode automatically bypasses all processing and any surround functions. In direct mode, digital processing is shut down to improve the sound quality and reduces digital noise with the AVR400 to an absolute minimum.

Note: when Stereo Direct mode is selected, no digital output is available and no bass management is performed, meaning that bass signals will not be redirected to a subwoofer.

Volume control

It is important to realise that the level of the volume indicator is not an accurate indication of the power delivered to your loudspeakers. The AVR400 often delivers its full output power long before the volume control reaches its maximum position, particularly when listening to heavily recorded music. In comparison, some movie sound tracks can appear very quiet, as many directors like to keep maximum levels in reserve for special effect sequences.

Headphones

To use headphones with the AVR400, plug the headphones into the **PHONES** socket in the centre of the front panel.

When headphones are plugged into the front panel **PHONES** socket, the outputs for Zone 1 are muted and the audio will be down-mixed to two channels (2.0). The two-channel down-mix is required so that the centre channel and surround information can be heard via the headphones.

Using Zone 2

Zone 2 provides the option for the occupants of the master bedroom, conservatory, kitchen, etc. to view or listen to a different source at a different volume level from the main zone (Zone 1).

Source selection and volume control for Zone 2 is achieved either by using an IR receiver in Zone 2 (see “Zone 2 control connections” on page E-46) or by switching over to Zone 2 control by pressing the front panel zone button or by pressing **AMP** followed by **SHIFT** then **OK** on the remote control. The front panel VFD display indicates that control has been switched to Zone 2.

```
STANDBY           22  50
DOLBY TRUEHD 5.1
```

To turn on Zone 2, press the Zone button (or shift+ok) then press the standby power button on the remote control. Press a source select button to select a different source to Zone 1.

```
FOLLOW 21         22  50
DOLBY TRUEHD 5.1
```

Note that Zone 2 control from within Zone 1 will pass automatically back to Zone 1 control after a few seconds of inactivity.

Zone 2 can also be controlled using a third-party programmable remote control or a home automation system. Please contact your dealer or installer for further details.

Extended front panel menu

Pressing the **MENU** key and holding it for longer than four seconds will bring up the Extended Menu, allowing you to perform the following:

Restore to factory defaults

This option allows you to restore all settings on your AVR400 to the defaults that it left the factory with.

Change remote code

The default RC5 system code the AVR400 responds to is 16. If required, for example due to another device in your system also using this RC5 system code, it can be changed to 19.





Restore secure backup

This option allows you to restore all settings to their state as saved using the ‘Store secure backup’ feature. This option is useful if settings are accidentally changed. It also allows the unit to be returned to the saved state following a firmware update.





Store secure backup

This option allows you to save all the AVR400 settings to a secure area of memory. The settings can be retrieved using the Restore option above.

– Enter PIN

Enter the secure backup PIN using the , ,  and  keys on the remote control (do not use the numeric keypad). The default PIN is 1234.

– Change PIN

Allows the PIN to be changed to a number other than the default. Enter the current secure backup PIN using the , ,  and  keys on the remote control (do not use the numeric keypad). The default PIN is 1234. After the current PIN has been entered correctly, enter a new PIN as prompted and again to confirm.

– EXIT

Cancel and return to the extended menu.

Updating firmware via USB

The firmware in your AVR400 can be updated using a USB flash drive containing a firmware update file.

front panel operation

Direct

Stereo Direct on/off. Provides a direct analogue path from the analogue inputs to the left and right front outputs. Switches off any surround processing modes and shuts down the DSP circuits for best stereo sound quality.

Display

This switches the display brightness between off/dim/bright.

Zone

Selects between Zone 1 and Zone 2 control.

Mute

Mutes all analogue audio outputs in the currently selected zone.

Power / Standby LED

This indicates the status of the receiver and is green when the AVR400 is powered on. Red indicates the AVR400 is in Standby mode.

Mode

Selects between Stereo and the available surround modes for the current source.

Info

Selects the information displayed on the lower left portion of the front panel.

OK

Used to enter selections made in the Setup menu. Press and hold to reset video outputs to the lowest resolution (HDMI: 480p; Component 480i).

Input

These buttons select the source connected to the corresponding input (or internal input)

Unused sources can be prevented from being selected in the setup menu.

Volume

Adjusts the analogue output volume in the selected zone (line out, speakers and headphones).

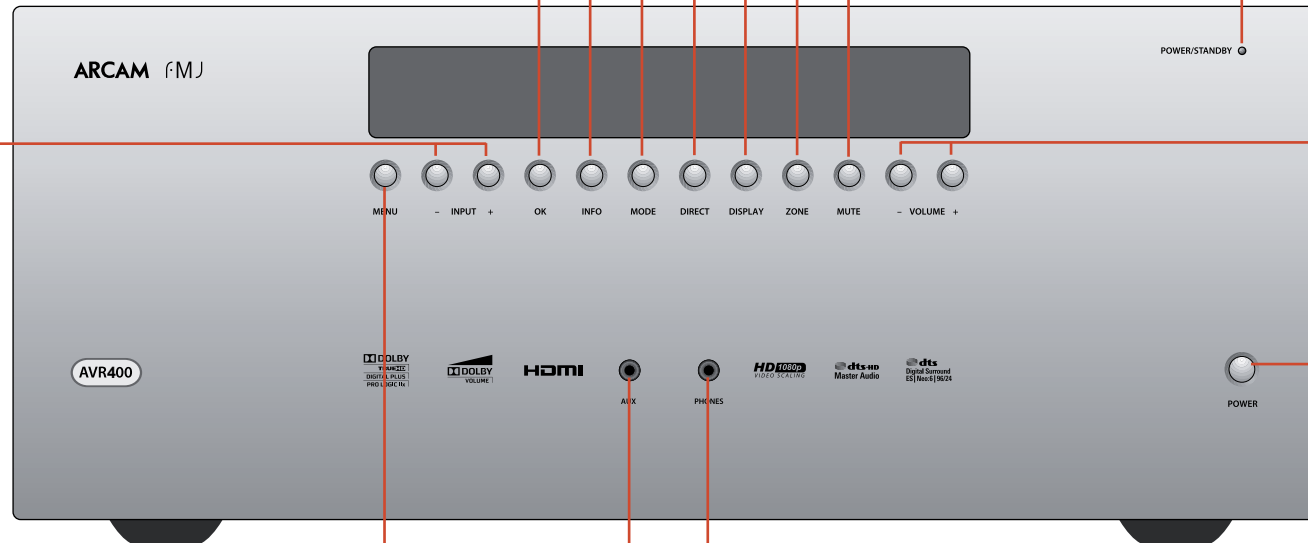

Power

Switches the main power to the AVR400 on and off. Once the unit is switched off, it should be left for at least ten seconds before switching on again.

Aux

Multi purpose auxiliary line level input, calibration microphone input and 3.5mm optical digital (SPDIF) input.

Phones

This socket accepts headphones with an impedance rating between 32Ω and 600Ω, fitted with a 3.5mm stereo jack plug.

Menu

Selects the Setup menus on the on-screen display (OSD).

Remote control receiver. This is positioned behind the display window, above the MENU button on the front panel. Ensure the receiver is in a clear line of sight from the remote control for operation. If this is not possible, use a separate sensor connected to the Z1 IR input on the rear panel.

remote control

The CR102 universal remote controller

The CR102 is a sophisticated 'universal' backlit remote control that can control up to eight devices. It is pre-programmed for use with the AVR400 and many other Arcam products (FM/DAB tuners, CD players and DVD players).

With its extensive built-in library of codes, it can also be used with thousands of third party audio-visual components – TVs, satellite and set-top boxes, PVRs, CD players, etc. See the list of codes at the back of this handbook, beginning on page 56.

The CR102 is a 'learning' remote, so you can teach it almost any function from an old single-device remote. You can also program the CR102 to issue a sequence of commands ('macros') from a single button press.

Using the remote control

Please keep in mind the following when using the remote control:

- Ensure there are no obstacles between the remote control and the remote sensor on the AVR400. The remote has a range of about 7 metres. (If the remote sensor is obscured, the Z1 IR remote control input jack on the rear panel is available. Please consult your dealer for further information.)
- Remote operation may become unreliable if strong sunlight or fluorescent light is shining on the remote sensor of the AVR400.
- Replace the batteries when you notice a reduction in the operating range of the remote control.



Inserting batteries into the remote control



1. Open the battery compartment by pressing the button on the back of the handset.

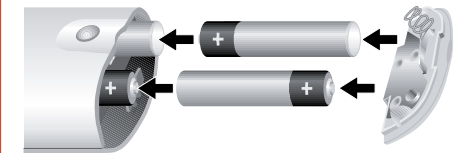

2. Insert four 'AAA' batteries into the battery compartment – two facing the top of the unit, and two facing the end, as in the diagram.
3. Lower the end cap onto the plastic locating plate in the handset. This acts as a hinge, and you can now push the end cap firmly into its locked position with a click.

Notes on batteries:

- Incorrect use of batteries can result in hazards such as leakage and bursting.
- Do not mix old and new batteries together.
- Do not use non-identical batteries together – although they may look similar, different batteries may have different voltages.
- Ensure the plus (+) and minus (-) ends of each battery match the indications in the battery compartment.
- Remove batteries from equipment that is not going to be used for a month or more.
- When disposing of used batteries, please comply with governmental or local regulations that apply in your country or area.

Useful information

Backlight

A blue backlight comes on for five seconds whenever a key is pressed. This helps you use the handset in subdued lighting conditions. It may be possible to hear a quiet tone being emitted from the remote control when the backlight is on. This is perfectly normal.

Power LED blinks

Short blinks indicate a valid key press.

Multiple short blinks convey information (such as a device code) or signal the beginning and successful completion of a programming sequence.

Long blinks indicate an invalid key press or entry.

The symbol  is used in the manual to indicate a power LED blink.

Timeouts and unassigned keys

Time out – After 10 seconds the CR102 exits the programming state and returns to normal operation.

Stuck key timeout – After any key is pressed continuously for 30 seconds, the CR102 stops sending IR transmission to conserve battery life. The CR102 remains off until all keys are released.

Unassigned keys – the CR102 ignores any unassigned key presses for a particular Device Mode and does not transmit IR.

Low voltage indicator

When the batteries are running down, the IR transmit indicator on the CR102 (the LED under the Power button) flashes five times whenever you press a button:



If this happens, please fit four new AAA alkaline batteries as soon as possible.

Device Mode / Source keys

As the CR102 can control your AVR400 as well as a range of other equipment, many of the buttons have more than one function depending on the 'device mode' selected on the remote control.

The Device Mode keys (shown below) select the source on the AVR400. If one of these keys is pressed briefly, a command is transmitted to change the source on the AVR400. Also the functionality of the remote control changes to operate the selected source device. It's like having eight different remotes in your hand!

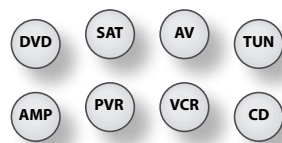

DVD	DVD player or Blu-ray Disc player
SAT	Satellite set-top box
AV	Audio-visual sound input (use with TV)
TUN	DAB, FM or AM tuner
AMP	Controls the amplifier and setup features of the AVR400
PVR	Auxiliary input, or an iPod® via an Arcam irDock or rLead
VCR	Personal Video Recorder (or Digital Video Recorder)
CD	Compact Disc player

If you press and hold a Device Mode key for about four seconds, you change the Device Mode of the CR102 *without* changing the signal source on the AVR400. This can also be done by pressing  followed by a Device Mode key (within two seconds). These two methods allow you to change which device the CR102 controls without also changing the AVR400 source, allowing uninterrupted listening.

Each Device Mode changes the behaviour of many of the CR102 keys to control the source device appropriately. For example:

In **CD** mode  plays the previous CD track.

In **AV** mode  issues the TV 'channel down' command.

The CR102 remains in the last selected Device Mode so it is not necessary to press a Device Mode key before every command key if all you are doing is playing or skipping tracks on a CD, for example.

Navigation keys



The Navigation keys steer the cursor in Setup menus or on-screen menus. They also replicate the navigation functions of original remotes supplied with other home entertainment devices in your system.

 confirms a setting.

Volume control

By default, the CR102 is set up so that the volume control buttons always control the volume of the AVR400, regardless of which Device Mode the remote is currently set for. This is known as volume 'punch through'.

For example, if you are listening to a CD, you will probably have the CR102 in **CD** Device Mode to control the CD player. You can use the volume controls on the remote directly to adjust the volume of the AVR400 without first having to press  to put the remote into **AMP** Device Mode. The volume buttons 'punch through' the **CD** Device Mode on the remote to the **AMP** Device Mode. Volume 'punch through' can be disabled individually for any Device Mode if desired.

The CR102 complies with Part 15 of the FCC rules

This equipment has been tested and found to comply with the limits for a class B digital device, pursuant to part 15 of the FCC Rules. These limits are designed to provide a reasonable protection against harmful interference in a residential installation. This equipment generates, uses, and can radiate radio frequency energy and if not installed and used in accordance with the instructions, may cause harmful interference to radio communications. However, there is no guarantee that interference will not occur in a particular installation. If this equipment does cause harmful interference to radio or television reception, which can be determined by turning the equipment off and on, the user is encouraged to try to correct the interference by one or more of the following measures:

Reorient or relocate the receiving antenna.

Increase the separation between the equipment and receiver.

Connect the equipment into an outlet or a circuit different from that to which the receiver is connected.

Consult the dealer or an experienced radio/TV technician for help.

Controlling other devices

Method 1 (Direct code setup)

This section describes the simplest (preferred) way to program the CR102's Device Mode keys to control the non-Arcam devices in your system.

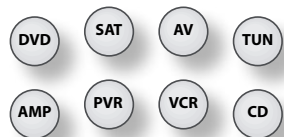

- Some of the modes are locked to Arcam operation but can be unlocked if required (see page E-50).
- **AMP** mode **only** controls Arcam equipment.

BD mode	Locked
SAT mode	Unlocked
AV mode	Unlocked
TUN mode	Locked
PVR mode	Locked
VCR mode	Unlocked
CD mode	Locked

Here is a specific example of how to program the **AV** key to control an Addison television. The principles for controlling other devices are exactly the same.

1. Make sure your device is switched on (not just on standby).
2. Find the correct Device Code table (e.g. TV) for the type of device you want to control from the CR102.
3. Find the row containing the codes for the manufacturer of your device (e.g. Addison) (page 56). The most popular code is listed first.
4. Press the appropriate Device Mode key (e.g. **AV**) on the CR102.
5. Press and hold **SHIFT** until the red Power LED blinks twice: ✨ ✨ (It actually blinks once when you press the key, then twice after about three seconds).
6. Enter the first four-digit device code using the number keys. The power key blinks twice: ✨ ✨.
7. Aim the CR102 at the device and press **OK**. If the device switches off, the setup is complete.
8. Turn your device back on and test all the CR102's functions to ensure they are working properly.
9. **Important!** Write your device code down on the right hand side of the page so you can remember it if you ever reset the CR102.

What if I still can't control my device?

- If your device doesn't respond, repeat the above steps until one of the device codes listed for your brand works.
- If none of the codes listed for your brand operates your device, or if your brand is not listed at all, try the Library Search Method described in the next section.

Notes:

- Some codes are quite similar. If your device does not respond or is not functioning properly with one of the codes, try another code listed under your brand.
- If your device's original remote control does not have a **POWER** key, press **▶** instead of **OK** when setting up your device.
- Remember to press the corresponding device key before operating your device.
- Many TVs do not switch on pressing **OK**. Please try pressing a number key ('channel select') to switch your TV back on.
- To search for the code for another device follow the instructions above, but press the appropriate device key instead of **AV** during step 2.

Method 2 (Library search)

This section describes another way to program the CR102 to control third-party equipment.

Library Search allows you to scan through all the codes contained in the CR102's memory. It can take a lot longer than the previous method, so only use this method if:

- Your device does not respond to the CR102 after you have tried all the codes listed for your brand.
- Your brand is not listed at all in the Device Code tables.

Example: To search for a TV code

1. Switch your TV on (not standby) and aim the CR102 at it.
2. Press **AV** on your CR102.
3. Press and hold **SHIFT** until the power LED blinks twice.
4. Press **9 9 1**. The power LED key blinks twice: ✨ ✨.
5. Press **OK**.
6. Aim the CR102 at your Television and press **▶** repeatedly until your Television turns off.
7. As soon as your television turns off, press **SHIFT** to store the code.

Every time you press **▶** the CR102 sends out a POWER signal from the next code contained in its memory. In the worst case, you may have to press this key up to 150 times, so patience is required! If you skip past a code, step back by pressing **◀**. Remember to keep pointing the CR102 at your Television while pressing this key.

Notes:

- Many TVs do not switch on by pressing **OK**. Try pressing a number key ('channel select') to switch your TV back on.
- If you cannot control your Television properly, please continue the Search Method: you may be using the wrong code.
- To search for the code for another device follow the instructions above, but press the appropriate Device Mode key instead of **AV** during step 2.
- If your device's original remote control does not have a **STANDBY** key, press **▶** instead during step 5.

Code blink-back

Once you have set up your CR102, you can blink back your device set-up codes for future reference.

Example: To blink back your Television code

1. Press the appropriate Device Mode key (e.g. **AV**) once.
2. Press and hold **SHIFT** until the red Power LED blinks twice: ✨ ✨ (It actually blinks once when you press the key, then twice after about three seconds).
3. Press **9 9 0**. The **OK** key blinks twice.
4. For the first digit of your four-digit code, press **1** and count all the red blinks. If there are no blinks, the digit is '0'.
5. For the second, third and fourth digits, repeat the previous step, pressing **2**, **3**, or **4** in order.

Now you have the four-digit code.

Make a note of the codes

Write down the codes for your devices in the boxes below for future reference.

Device	Code
1	
2	
3	
4	
5	
6	
7	
8	















AMP Device Mode

















The  Device Mode button configures the CR102 to control the AVR400. Pressing this button does not affect the currently selected input on the AVR400.









IMPORTANT: The CR102 must also be in AMP Device Mode to control the following sources: **MCH** (multi-channel analogue), **AUX**, **NET** (optional network audio), **USB**, **IPOD** (for use with the optional Arcam rLead or irDock).

However to control the internal Tuner (AM/FM/DAB (if fitted)) the CR102 must first be in TUN Device Mode (see later).

The functionality of the CR102 is context sensitive for the internal sources and is described in the following table.







	Single press – Toggles AVR400 power between standby and on in the current zone (zone in which the command is received). Press and hold – Forces all AVR400 zones into standby, regardless of which zone the command was received in.
	The number keys can be used for source selection (without changing the CR102 Device Mode). Alternatively the Device Mode buttons can also be used with the SHIFT key. <ol style="list-style-type: none"> ① SAT (satellite) input ② AV input ③ TUNER input ④ BD input ⑤ DISPLAY input ⑥ VCR input ⑦ CD input ⑧ AUX (front panel) input ⑨ MCH (multichannel) input
	Selects the Display input on the AVR400 (television Audio Return Channel).
	(for IPOD and NET sources)
	Modifies many keys (see individual key descriptions below).
	Selects MCH (multichannel) input on the AVR400 SHIFT +  selects AUX input on the AVR400
	Selects IPOD input on the AVR400 SHIFT +  selects network (NET) internal input on the AVR400
	Navigate menus OK confirms a setting (equivalent to 'Enter' or 'Select' on some remote controls) SHIFT +  increases the picture resolution. SHIFT +  turns current zone (in which command is received) on SHIFT +  turns current zone (in which command is received) off.
	Cycles through the available surround and downmix modes.
	Displays the AVR400 setup menu on the On Screen Display (see page E-34).

	Cycles through the front panel display's brightness options
	Toggles the mute function of the AVR400
	(track control for IPOD and NET sources) SHIFT +  Follow Zone1 source. When the command is received in Zone2 the source for that zone follows whatever input source is selected in Zone1
	Decrease (-) and increase (+) AVR400 volume
	Stereo direct on/off. Provides a direct analogue path from the analogue inputs to the left and right front outputs. Switches off any surround processing modes and shuts down the DSP circuits for the best stereo sound quality.
	Displays the room EQ settings menu
	(for IPOD and NET sources)
	Calls up a pop-up (and front screen) to adjust the bass setting for a particular input.
	Brings up the speaker trim menu. Use the  ,  ,  and  navigation buttons. Press TRIM again to exit the speaker trim menu. As this is a temporary adjustment, these additional trim levels are reset back to the values set in the Speaker Levels menu when the unit is turned off or the unit is put into standby. These temporary trim levels override the speaker levels found in the setup menu.
	Delays may be introduced into the video signal by video processing which causes a mismatch between the audio and video timing. You will notice this by speech sound being out of synchronization with the lip movements in the video. To compensate for this, you can adjust the lip sync delay. Press the SYNC button and use the  and  navigation buttons. Press again to exit the lip sync trim menu.

	Brings up a temporary subwoofer trim control. Use the  and  navigation buttons. Press SUB again to exit the sub trim menu. As this is a temporary adjustment, the sub trim level is reset back to the value set in the Speaker Levels menu when the unit is turned off or the unit is put into standby.
	Calls up a pop-up (and front screen) to adjust the treble setting for a particular input.
	(for IPOD and NET sources)
	(for IPOD and NET sources)
	(for NET source)
	Cycles through the information displayed on the lower left portion of the front panel display.

iPod commands

The iPod interface is selected by pressing  in AMP Device Mode on the CR102. When connected to an iPod via an optional rLead/irDock, the keys below are used to navigate music files in AMP Device Mode.

	Navigate the files on screen. OK selects/play the highlighted file.
	Toggles random (shuffle) play of the playlist on and off. SHIFT +  cycles through the repeat options
	Selects the previous/next track in the current playlist
	Begins or resumes playback at the currently highlighted track
	Toggles pause and playback of the current track
	Stops playback

Network commands

The AVR400 Network client is selected by pressing **(SHIFT) + (IPOD)** in **AMP** Device Mode on the CR102.

When using the network client, the keys below are used to navigate music files in **AMP** Device Mode.

	Navigate the files and menus on the screen. OK selects the highlighted file or enters the highlighted menu on the screen
RPT 	Toggles random ('shuffle') play of the playlist on and off SHIFT + (RND) cycles through the repeat options
	Selects the previous/next track in the current playlist
EQ 	Begins or resumes playback at the currently highlighted track
EFFECT 	Pauses the currently-playing track
SYNC 	Stops playback
FAV+ 	Adds the currently displayed radio station to favourites list when using the internet radio function
FAV- 	Removes the currently displayed radio station from favourites list when using the internet radio function
HOME 	Returns navigation to the top level of the network client menus ('Home')
INFO 	Cycles through the information displayed on the lower left portion of the front panel display

(TUN) TUN Device Mode

The **(TUN)** Device Mode button configures the CR102 to control the tuner functions of the AVR400. Pressing this button also selects **TUNER** as the source.

When switching to **TUNER** from a different source, the AVR400 enters the last used tuner band, be it AM / FM / DAB (if fitted). Further presses of the **TUN** Device Mode button cycle through the available tuner bands.

Further information on the tuner can be found in the 'Tuner Operation' section on page E-44.

	(not used)
0...9	Number keypad used to store and recall presets
	Allows selection of previously stored Tuner presets.
	AM/FM Tuner: allows frequency tuning. DAB Tuner (where fitted): scrolls through the channel list.
OK	Selects (tunes to) the currently displayed preset, or selects the currently displayed DAB channel when scrolling through the channel list.
SETUP	Page up to the previous 10 presets on screen
TITLE	Page down to the next 10 tuner presets on screen
AUDIO	Delete the currently highlighted preset.
INFO SUBT	Cycles through the information displayed on the lower left portion of the front panel display.

(DVD) DVD/BD Device Mode





















The **(DVD)** Device Mode button configures the CR102 to control the functions of Arcam Blu-ray Disc and DVD players, although this can be changed (see page E-25). Pressing this button also selects **BD** as the AVR400 source.









	Toggles power between standby and on
0...9	Searches for and plays the track corresponding to the key pressed
PHONO TAPE	Selects Display input on the AVR400.
RPT 	Toggles random ('shuffle') play on and off. SHIFT + (RND) cycles through the repeat options (track, disc, etc)
(SHIFT)	Modifies many keys (see individual key descriptions, below)
AUX 	Selects multichannel (MCH) input on the AVR400 SHIFT + (MCH) selects AUX input on the AVR400
NET 	Selects IPOD input on the AVR400. SHIFT + (IPOD) selects network (NET) internal input on the AVR400
	Navigate setup and BD programme selection menus. OK confirms a setting ('Enter' or 'Select' on some remotes). SHIFT + (UP) to switch on from standby SHIFT + (DOWN) to switch to standby from on.
(MODE)	Cycles through available surround sound modes. SHIFT + (MODE) changes the HDMI setting.
(MENU)	Activates BD player menu, if available.
(DISP)	Cycles through the front panel display's brightness options. SHIFT + (DISP) enables RPT A-B functionality
	Toggles the mute function. By default this key operates the AVR400 Mute
	Press and release to skip back to the beginning of the current/previous track.
	Press and release to skip forwards to the beginning of the next track.

(-) (+)	Decrease (-) and increase (+) AVR400 volume
	Fast rewind. SHIFT + (Fast rewind) cycles through slow play backwards speeds
	Starts the playback of a BD. SHIFT + (Play) cycles through the Angle options on an Arcam BD player.
	Pauses BD play-back. Press (Play) to restart playback. SHIFT + (Pause) cycles through Zoom options.
	Fast forward. SHIFT + (Fast forward) cycles through slow forward speeds
TRIM 	Ejects disc. SHIFT + (Trim) displays speaker Trim menu on Arcam BD players.
	Stop playback of a BD
	Start recording (on products that have this feature).
(SRCH)	Displays Search menu with Title, Track and Time options.
FAV+ 	Displays Setup menu. SHIFT + (SETUP) displays programming screen on Arcam BD players
FAV- 	Displays Title menu. SHIFT + (TITLE) clears bookmark, search and program display entries on Arcam BD players
HOME 	Changes Audio decode format (Dolby Digital, DTS, etc.). SHIFT + (AUDIO) displays the 'Memory' function (Bookmarks)
INFO 	Cycles through BD subtitle language options, if available. SHIFT + (SUBT) displays STATUS INFO on Arcam BD players

SAT Device Mode



















The  Device Mode button configures the CR102 to control the functions of a satellite receiver. You will need to configure this Device Mode to work with your equipment. Pressing this button also selects **SAT** as the AVR400 source.









	Toggles power between standby and on
	Functions as original remote number key.
	Selects Display input on the AVR400.
	Toggles between the available inputs on your satellite receiver
	Modifies many keys (see individual key descriptions, below)
	Selects multichannel (MCH) input on the AVR400. SHIFT +  selects AUX input on the AVR400.
	Selects IPOD input on the AVR400 SHIFT +  selects network (NET) internal input on the AVR400
	Navigate menus. OK confirms a setting (equivalent to 'Enter' or 'Select' on some remotes).
	Controls Backup function, if available.
	Performs same function as on original remote, if available.
	On some Satellite and Cable set top boxes this key functions as the Guide key to open the EPG (Electronic Program Guide).
	Toggles the mute function. By default this key operates the AVR400 Mute
	Channel down
	Channel up
	Decrease (-) or increase (+) AVR400 volume
	Fast rewind
	Starts the playback
	Toggles pause of playback
	Fast forward

	(not used)
	Stop playback
	Start recording
	(not used)
	Duplicates function of RED key for some Satellite and Cable set-top boxes
	Duplicates function of GREEN key for some Satellite and Cable set-top boxes
	Duplicates function of YELLOW key for some Satellite and Cable set-top boxes
	Duplicates function of BLUE key for some Satellite and Cable set-top boxes

AV Device Mode





















The  Device Mode button configures the CR102 to control the functions of a television or other display device. You will need to configure this Device Mode to work with your equipment. Pressing this button also selects **AV** as the AVR400 source.









	Toggles power between standby and on. (Some TVs require you to use a number key to turn them on.)
	Functions as original remote number key – usually for channel selection.
	Selects Display input on the AVR400.
	Toggles between the available inputs on your display device (e.g. TV/AV)
	Modifies many keys (see individual key descriptions, below)
	Selects multichannel (MCH) input on the AVR400. SHIFT +  selects AUX input on the AVR400.
	Navigate setup and programme selection menus. OK confirms a selection (equivalent to 'Enter' or 'Select' on some remotes).
	EXIT function on some models.
	Functions as original remote key, if available.
	Display INFO or OSD (On Screen Display) function, if available.
	Toggles the mute function. By default this key operates the AVR400 Mute
	Channel down
	Channel up
	Decrease (-) and increase (+) AVR400 volume.
	Toggles TEXT page on/off
	TEXT page off
	Turns Programme-In-Programme (PIP) on, if available

	Activates PIP move, if available
	Activates PIP swap, if available
	Activates PIP freeze, if available
	Activates PIP channel up, if available
	Activates PIP channel down, if available
	Duplicates function of RED key for Text TV
	Duplicates function of GREEN key for Text TV
	Duplicates function of YELLOW key for Text TV
	Duplicates function of BLUE key for Text TV

PVR Device Mode





















The  Device Mode button configures the CR102 to control the functions of a video recorder or similar device. You will need to configure this Device Mode to work with your equipment. Pressing this button also selects **PVR** as the AVR400 source.









	Toggles power between standby and on.
	Functions as original remote number key.
	Selects Display input on the AVR400.
	Toggles between available inputs (e.g. AV1, AV2)
	Modifies many keys (see individual key descriptions, below)
	Selects multichannel (MCH) input on AVR400. SHIFT +  selects AUX input on the AVR400.
	Selects IPOD input on AVR400. SHIFT +  selects network (NET) internal input on the AVR400.
	Navigate setup and programme selection menus. OK is equivalent to 'Enter' or 'Select' on some remotes.
	Operates the Exit function if the PVR uses this feature
	Turns on the Menu function if the PVR uses this feature
	Toggles display between TV and PVR
	Toggles the mute function. By default this key operates the AMP Mute
	Channel down
	Channel up
	Decrease (-) and increase (+) AVR400 volume
	Fast rewind
	Play
	Toggles pause of playback

	Fast forward
	Operates the Favourites function if the PVR uses this feature.
	Stop playback
	Starts recording
	(not used)
	Duplicates function of RED key (if used)
	Duplicates function of GREEN key (if used)
	Duplicates function of YELLOW key (if used)
	Duplicates function of BLUE key (if used).

VCR Device Mode



















The  Device Mode button configures the CR102 to control the functions of a video recorder or similar device. You will need to configure this Device Mode to work with your equipment. Pressing this button also selects **VCR** as the AVR400 source.













	Toggles power between standby and on.
	Functions as original remote number key.
	Selects Display input on the AVR400.
	Toggles between available inputs (e.g. AV1, AV2)
	Modifies many keys (see individual key descriptions, below)
	Selects multichannel (MCH) input on AVR400. SHIFT +  selects AUX input on the AVR400.
	Selects IPOD input on AVR400. SHIFT +  selects network (NET) internal input on the AVR400.
	Navigate setup and programme selection menus. OK is equivalent to 'Enter' or 'Select' on some remotes.
	Operates the Exit function if the VCR uses this feature
	Turns on the Menu function if the VCR uses this feature
	Toggles display between TV and VCR
	Toggles the mute function, if available. By default this key operates the AMP Mute
	Channel down
	Channel up
	Decrease (-) and increase (+) amplifier volume
	Fast rewind
	Play
	Toggles pause of playback

	Fast forward
	Ejects tape
	Stop playback
	Starts recording
	(not used)
	Duplicates function of RED key (if used)
	Duplicates function of GREEN key (if used)
	Duplicates function of YELLOW key (if used)
	Duplicates function of BLUE key (if used).

CD Device Mode

The  Device Mode button configures the CR102 to control the CD functions of Arcam CD players, although this can be changed (see page E-25). Pressing this button also selects **CD** as the AVR400 source.

	Toggles power between standby and on.
	Functions as original remote number key.
	Selects Display input on the AVR400.
	Toggles random ('shuffle') play on and off. SHIFT +  cycles through the repeat options (track, disc, etc.).
	Modifies many keys (see individual key descriptions, below)
	Selects multichannel (MCH) input on AVR400. SHIFT +  selects AUX input on the AVR400.
	Selects IPOD input on AVR400. SHIFT +  selects network (NET) internal input on the AVR400.
	Navigates track listings if supported by the player. OK selects the currently highlighted track if supported by the player
	Changes the time display modes on Arcam CD player
	(not used)
	Cycles through the front panel display's brightness options. SHIFT +  enables RPT A-B functionality if supported by the player.
	Toggles the mute function. By default this key operates the AVR400 Mute.
	Press and release to skip back to the beginning of the current/previous track.
	Press and release to skip forwards to the beginning of the next track.

	Decrease (-) and increase (+) AVR400 volume.
	Fast rewind
	Play
	Toggles pause of playback
	Fast forward
	Open/close disc tray
	Stop playback
	Start recording (on products that have this feature)
	Scans first 10 seconds of each track on CD, if supported by the player (Audio search)
	Starts Program mode
	Clears programmed item
	(not used)
	(not used)

essential setup

Before you use your AVR400 it is essential that you enter some information into the Setup menus about your speaker configuration. This allows the AVR400 to process any surround sound digital source to exactly match your system and give you the ultimate surround sound experience.

There are three pieces of vital information which are outlined in the sections: 'Speaker Types', 'Speaker Distances' and 'Speaker Levels'.

The way you enter this information manually into the AVR400 is given later in the 'Setup Menus' section on page E-34. The settings can also be established automatically using the Arcam Auto Speaker Setup function. However it is important to understand why these speaker settings must be entered, which is why this section is presented first.

Speaker types

You need to set the type of speakers that you have connected to your AVR400:

Large	capable of full frequency range reproduction
Small	not capable of full frequency range reproduction at the low frequency end
None	speaker not present in your configuration

The terms 'Large' and 'Small' do not necessarily relate to the physical size of your speakers. As a rule of thumb, if a speaker cannot reproduce a flat frequency response down to about 40Hz (and very few can!) it is often better to consider them as 'Small' for setup purposes of home cinema.

When a speaker is set to 'Small', very low frequency sounds are redirected away from that speaker to a 'Large' speaker or a subwoofer, which are far better suited to reproducing these low frequency sounds.

Note that it is not possible to set all speakers to 'Small' unless there is a subwoofer in your speaker configuration. If you do not have a subwoofer, you will be forced to set your front speakers to 'Large'.

(Advanced users may wish to automatically override the 'Small' speaker setting for purely stereo music listening when not watching movies. This can be achieved in the 'Input Config.' menu – see page E-35.)

Crossover frequency

If you have set any speakers as being Small, then you will be required to set a value for the crossover frequency. This is the frequency below which signals are filtered away from these Small speakers and redirected to Large speakers or the subwoofer (if present). A frequency of 80Hz is often a good starting point, however you will probably have to experiment with different values to find the best value for your system or consult your speaker handbook.

MCH sub level

If a subwoofer is present, this setting allows for a 10dB compensation on the subwoofer output when using the MCH input as required by many DVD-A players with audio outputs.

Use Channels 6+7 for

If not used in the main zone, it is possible to assign the Surround Back channels to bi-amp the Front Left/Right channels or to provide an amplified output to Zone 2.

Speaker Distances

It is essential for the distance from each speaker to the listening position to be accurately measured and entered into the 'Setup' menu. This ensures that the sounds from the various speakers arrive at the listening position at the correct time to recreate a realistic surround effect. The distance can be entered in centimetres or inches.

Speaker Levels

Finally the levels of all the speakers in the system need to be adjusted to match each other at the listening position, again to create a proper surround effect. To help with this the AVR400 can generate a test noise for each speaker which should be measured with a sound pressure level (SPL) meter. The meter should be set to 'C' weighting and slow response. The level of noise measured at the listening position from each speaker should be adjusted on the Speaker Trims page of the Setup menu so that the meter reads 75dB SPL. It does not matter what the system volume setting of the AVR400 is before turning the test noise on as the volume setting is over-ridden for the duration of the speaker noise test.

There are several basic SPL meters on the market at reasonable prices aimed at home cinema enthusiasts. Check your local technology store, search online or ask your dealer.

If you do not have an SPL meter, you can try to adjust the noise level of each speaker by ear. In this case it is not possible to adjust the speakers to the absolute 75dB SPL volume level, but you should aim for all speakers sounding equally loud. Setting speaker test noise levels by ear is not recommended as it is very difficult to do accurately, but is often better than doing nothing at all!

auto speaker setup

There is a proprietary automatic loudspeaker setup function built into your AVR400. The Arcam Auto Speaker Setup function attempts to set all the essential speaker settings for all the speakers in your system. It also calculates room equalisation (Room EQ) filter values to remove some of the worst effects of resonant frequencies in the listening room.

Your AVR400 package is supplied with a calibration microphone, which should be inserted into the AUX jack socket on the front panel and positioned at the main listening position. This microphone picks up the special calibration tones generated by the speakers when Auto Speaker Setup is run. The AVR400 then analyses the signal and computes:

- which speakers are present,
- speaker type,
- speaker distance,
- speaker level,
- crossover frequency to the subwoofer (or large front speakers if no subwoofer is present),
- problem resonant frequencies in the room which need control by filtering.

To help the system be as accurate as possible when performing Auto Speaker Setup, there are a few guidance rules that should be followed:

- Minimise any background sounds in the listening room and other nearby rooms.
- Close all windows and doors in the listening room.
- Turn off all fans including air-conditioning systems.
- If holding the microphone in the hand rather than mounting on a tripod or similar, keep your hand and fingers still to avoid generating 'handling noise'.
- Position the set up microphone pointing upwards at roughly head height in the normal listening position. It is not necessary to point the microphone directly at the speaker generating the test tone. (It helps if you are able to position the microphone exactly where your head would normally be for listening, with the microphone in direct unobstructed view of all speakers.)
- If your system includes an active subwoofer, start by setting its output level / gain control to a value halfway between maximum and minimum.

When activated, a calibration tone is played through each channel of the AVR400 in turn, including the subwoofer channel. The calibration tone cycles round each of the speakers multiple times as the different parameters are calculated. If you do not have a full 7.1

speaker configuration there will be periods of silence between some speaker channels. Follow the 'progress' information on-screen.

After all the channels have been measured, a summary of the speaker configuration will be displayed on-screen. You can then choose to accept the settings, re-measure your system again or cancel Auto Speaker Setup without storing the settings.

The Auto Speaker Setup function is found within the Setup menus, see page E-36. **By default, Room EQ is not applied to any of the source inputs.** You should enable Room EQ on inputs you think benefit from this feature, as required, by listening when playing typical source material through each input. This is enabled from within the Input Config menu.

While room equalisation can help to reduce problems with listening room acoustics, it is usually far better to try to solve these problems with the room directly. Proper loudspeaker positioning, acoustic wall treatments and moving the listening position away from walls should produce far better results overall. However it may be difficult to do this in a home environment, so Room EQ is your next best choice.

Problems

We advise you to look over the reported measurements on the screen following Auto Speaker Setup for any obviously incorrect results, in particular to ensure the reported speakers match your configuration and that the speaker distances to the listening position appear roughly correct. If the results are not what you expected re-run Auto Speaker Setup.

The Auto Speaker Setup function is normally quite accurate but occasionally false results can be generated. Problems may be as a result of:

- external sounds or rumbling / handling noises picked up by the microphone
- sound reflections off hard surfaces (e.g. windows or walls) close to the listening position,
- very strong acoustic resonances within the room,
- obstacles (such as a sofa) between speakers and the microphone.

If you are still experiencing difficulties or you wish to have the most accurate results for ultimate surround performance, we recommend using the manual method of establishing speaker distances and levels.

Using a subwoofer

If your system includes an active subwoofer you may need to re-run Auto Speaker Setup with the subwoofer output level / gain control set to a higher or lower value, if the summary screen reports problems setting the subwoofer up.

Auto Speaker Setup will attempt to choose a crossover frequency that allows the smoothest low frequency transition from the main speakers to the subwoofer. However if this does not produce pleasing results we recommend manually trying other crossover frequencies to find something more to your preference.

See the next sections for information of how to enter or change speaker settings manually.

NOTE

Auto calibration is possible only for a 7.1 Or 5.1 Speaker configuration. Other speaker configurations, such as a 2.1 setup (left, right and subwoofer), must be configured manually using the speaker configuration menus (see page E-37), referring to the guidelines on page E-32 for speaker types, speaker distance and speaker levels.

setup menus

The Setup menus allow you to configure all aspects of your AVR400. The next few pages will go through the menu items and explain their function. The Setup menus will probably look quite daunting if you are new to setting up home cinema, but the majority of them need only be configured once when you first install the system (or if your system changes or you move house!)

The only way to view the Setup menus is on your display device (TV or projector) using the on-screen display (OSD) capability of the AVR400. To view the OSD for the initial setting up, connect any of the video outputs to your display device. You do not need to have a video source connected to the AVR400 video inputs.

Entering Setup mode

To enter the setup menu, press the **MENU** button on the remote control or front panel. The front panel display shows 'SETUP MENU' and the setup menu (pictured right) is displayed.

Unstable OSD menu or picture display?

The default AVR400 output video resolution when first powered up out of the box is 525-line/60Hz NTSC for analogue video and "Preferred" for digital video. This has been chosen as most display devices can synchronise to this automatically. This can be changed in the Video Outputs section of the Setup Menus.

If the output resolution and frame rate is forced to a setting your display device does not support, the picture may become unstable or may not display at all. To reset the output video resolution and frame rate to the default values to restore the display, press and hold the front panel **OK** button for three seconds. Alternatively, press **SHIFT** then **▶** on the remote control to cycle between different output resolutions until the picture returns.

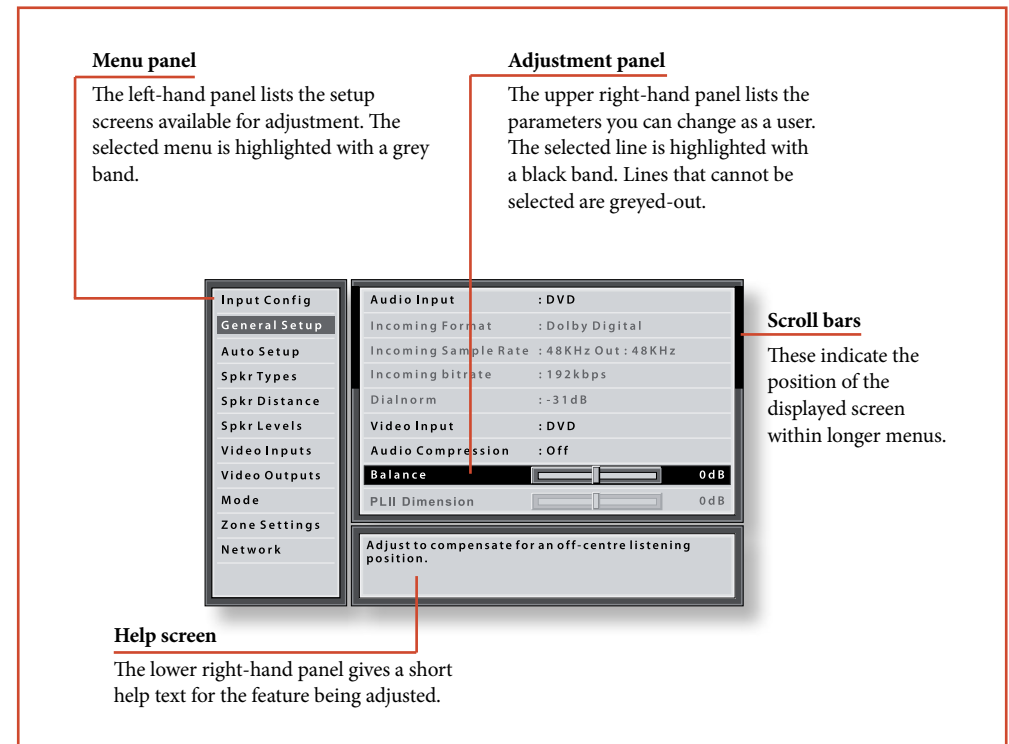

Navigating the setup menu

... using the remote control

The setup menu can be navigated by using the cursor (arrow) keys on the remote control. This is by far the easiest method.

1. To enter the setup menu, press the **MENU** button (which is located immediately under the navigation buttons).
2. Use the **▲** and **▼** keys to navigate up and down the main section headings in the left-hand panel.
3. Once you have the main section that you require highlighted, use the **▶** key to enter the section.
4. Use the **▲** and **▼** keys to navigate up and down the section settings in the right-hand panel. Some settings may be greyed out. These are either for information only (e.g. incoming sampling

frequency) or are not currently selectable (e.g. network IP address when DHCP is used). Scroll bars on the sides of the right hand panel indicate your position in the settings list where there are more items than can be displayed at once.

5. Pressing **OK** selects a setting to change it, pressing **OK** again de-selects the setting.
6. At any time, press the **MENU** button to exit the menu. Any changes to settings are saved.

... using the keys on the front panel

The AVR400 front panel controls can be used to configure the unit. Follow the instructions for using the remote control, in this case using **INPUT-** for down, **INPUT+** for up, **INFO** for left and **OK** for right.

Input Config.

The audio and video settings on this page of the Setup menu can be tailored *specifically and independently to the currently selected input*.

When a different input is selected on the Input line, all the input-specific settings for that input are displayed below it. These settings are applied to the named Input only and are stored in memory and recalled each time the unit is powered up and whenever that input is selected.

Input – The currently selected input connectors to which the settings below relate.

Name – The display name of the input. You can change the name of any input to more closely match your setup. For example, if you had two satellite receivers, you could connect the main receiver to the Sat audio and video input connectors and change the Name to 'SAT 1'. You could then connect the second satellite receiver to the VCR audio and video input connectors, but change the VCR Name to 'SAT 2'. It is then clearer to users of your AVR400 which inputs they wish to select when scrolling through.

Lip Sync – Each input can have its own setting to add a time delay between the audio and video signals to compensate for the sound and picture not being synchronised. This is normally required when video processing is used in the system for scaling or de-interlacing video. The range of lip sync delay is 0 to 250 milliseconds.

The lip sync adjustment can only correct for delayed video. If the audio is late set lip sync to its minimum.

Mode – Sets the initial audio decode mode for stereo sources on this input.

- Last Mode recalls the last used setting for this input when a stereo source was applied. See section “Two-channel source modes” on page E-40 for more information.

Ext. Mode – Sets the initial audio decode mode for multi-channel digital sources on this input.

- Last Mode recalls the last used setting for this input when a stereo source was applied. See section “Multi-channel source modes” on page E-41 for more information.

Treble –
Bass –

These allow you to alter the bass and treble tone controls for all currently active speakers for each individual

input. For example, if your PVR source sounds a little bass light, you can always correct for this by selecting PVR on the Input line at the top of this menu and add 2 or 3dB to the Bass control. Then, whenever the PVR input is selected, the bass is automatically boosted for as long as that input is selected.

Room EQ – When the Auto Speaker Setup function is run it also calculates Room Equalisation coefficients to remove some of the worst effects of resonant frequencies of the room at the listening position. By default Room EQ is not applied to any of the source inputs, however you can enable them on a per-input basis as you wish.

- **Not Calculated:** (Information only) Auto Speaker Setup has not been run or has errors so cannot be selected.
- **On:** Room EQ is applied to the current source.
- **Off:** Room EQ is not applied to the current source.

Input Trim – Sets the maximum analogue input signal level (sensitivity) on this input before the ADC (Analogue-to-Digital converter) signal path clips. Options are 1, 2 and 4 volts RMS maximum input. The default is 2Vrms maximum.

For example, analogue sources with low output levels may benefit by choosing the 1V maximum setting. This helps maximise signal-to-noise performance of the AVR400 and also helps keep the various analogue sources sounding about the same level for any given AVR400 volume control setting.

Dolby Volume – Dolby Volume is an intelligent system that improves the perceived audio frequency response at lower listening levels and corrects for volume inconsistencies between sources (e.g. a rock radio station and a BD) and between programming (e.g. a TV show and advertisement breaks).

- **On:** Dolby Volume is applied to this input.
- **Off:** (default) Dolby Volume is not applied to this input.

Dolby Leveller – This setting of Dolby Volume controls how closely quiet and loud sources and programme content are matched to each other, based on the ear's perception of loudness. The range of values is 0 (minimal levelling) to 10 (maximum levelling). The default setting is 2, however we recommend experimenting with higher values if your source material is less closely matched in level. If the Volume Leveller function is set off, no level matching between sources and programme material is performed. Note however that turning the Dolby Leveller setting of Dolby Volume to 'Off' is not the same as turning the entire

function of Dolby Volume to 'Off', as volume related frequency response processing is still active. See “Dolby volume” on page E-42 for more information.

DV Calib. Offset – The Calibration Offset parameter of Dolby Volume allows you to compensate for speaker efficiencies and listening position. The default value is 0 and this should normally produce a good result when the AVR400 speaker levels are set using a sound pressure level meter.

See “Dolby volume” on page E-42 for further information on Calibration Offset.

Surround EX – Sets how the AVR400 should configure its decode mode when a Dolby Digital EX bitstream is received. Note that this setting only applies if you have Surround Back loudspeakers. You may wish to experiment with these two decode modes to see which you prefer with Dolby Digital EX encoded material. Options are Auto DD EX, Auto PLIIx and Manual.

- **Auto DD EX:** When a Dolby Digital EX-flagged bitstream is detected, the decode mode automatically changes to Dolby Digital EX. This can be temporarily overridden by pressing the MODE button on the remote or front panel.
- **Auto PLIIx Movie:** When a Dolby Digital EX-flagged bitstream is detected, the decode mode automatically changes to Pro Logic IIx Movie. This can be temporarily overridden by pressing the MODE button on the remote or front panel.
- **Manual:** The received Dolby Digital EX is treated as if it is an ordinary Dolby Digital stream in that it does not automatically select the EX or PLIIx decode modes. Instead, the previously used decode mode for a multi-channel digital source on this input is applied. However, either of the EX or PLIIx decode modes can be applied manually by pressing the MODE button.

Stereo Mode – If you have configured your system to have a subwoofer, then you have the flexibility to choose how bass information is distributed between the front left/right speakers and the subwoofer when listening to stereo (two channel only) analogue and digital sources. Choose the option which gives you the most solid, even sounding bass. If you are using a subwoofer for stereo, please also see Sub Stereo below to set the level of the subwoofer. For best results test with a set-up disc or live programme material. This setting can be used to override your normal speaker settings in the Spkr Types menu whenever the AVR400 plays stereo material. It is quite common to find that two channel stereo music

listening is best done with a slightly different sub/speaker setting than for surround movies.

- **As Spkr Types:** When an analogue or digital stereo source is played, your normal speaker configuration (as in Spkr Types menu) is used to reproduce the signal.
- **Left/Right:** Full frequency stereo information. All audio is sent to the front left and right speakers only without any bass redirection. You can use this setting if you consider your front left/right speakers to be able to handle the full frequency range of music. If you have set your front left/right speaker size as Small in the Spkr Types setup page, you may wish to use this option to override the setting to Large for stereo music listening, if you have full frequency range left/right speakers. It can often be beneficial to set full frequency range speakers to Small in the Spkr Types setup page for use with movies, if you have a subwoofer in your system. Doing so may deliver more impact on movie soundtracks as subwoofers are designed to handle reproduction of high bass content. However you may find that for stereo music a better overall result is obtained by not using the subwoofer and effectively treating the front left/right speakers as Large.
- **Left/Right+Sub:** Full frequency range stereo is fed to the front left and right speakers and extracted bass is sent to the subwoofer. In this case the low frequency information is effectively duplicated.
- **Sat+Sub:** Use this setting if you really do have Small satellite front left and right speakers, or if you prefer the overall sound of bass being handled by the subwoofer. Full bass management is used so that analogue and digital stereo sources are fed to the DSP where the bass is filtered off front left and right and redirected to the subwoofer.

NOTE

The Stereo Mode function is not available when using an analogue source in Stereo Direct mode.

Sub Stereo – If Left/Right+Sub or Sat+Sub is selected in Stereo Mode above, this setting adjusts the level of the subwoofer when the source is two channel stereo.

Brightness – Sets the video brightness for this input. This setting can be used to compensate for an overly dark or bright source picture on this input when compared with other video sources.

Contrast – Sets the video contrast for this input. This setting can be used to compensate for too much or too little contrast in the source picture on this input when compared with other video sources.

Colour – Sets the video colour saturation for this input. This setting can be used to compensate for too much or too little colour in the source picture on this input when compared with other video sources.

Picture Mode – Sets how the video processor in the AVR400 interprets the video on this input. Normally the video processor automatically detects the original source type and correctly sets either Video mode or Film mode processing. In the unlikely event that the video processor misinterprets the video type, resulting in subtle picture artefacts, the video processor can be manually forced into Video mode or Film mode. This function should normally be set to Auto.

Edge Enhancement – Sharpens the picture from a source on this input.

MPEG N.R. – Removes artefacts in overly compressed digital video from a source on this input.

Noise Reduction – Removes random noise within the picture from a source on this input.

Component Mode – Configures the current three-wire high quality analogue video input for component (YUV) video signals or RGB video signals. It is important to match the setting to the incoming video format otherwise the colours will be incorrect and the picture may be unstable.

Options are Normal, RGsB and RGB+Sync.

- **Normal:** (default) the three-wire input is configured for normal Component (YUV / YPbPr) analogue video.
- **RGsB:** the three-wire input is configured for RGB analogue video with video 'sync-on-green'.
- **RGB+Sync:** the three wire input is configured for RGB analogue video, with the video sync signal on the composite input for the current named source.

You should typically select RGB+Sync if you are using a standard SCART to 4-wire phono breakout cable to connect an RGB SCART source.

NOTE: If RGB+Sync is selected, the S-Video and Composite inputs cannot be selected as video inputs for the current source.

Video Source – Selects the video signal connection for this source. The default is HDMI; this setting must be changed if another connection is used.

■ **HDMI:** the unit is forced to use the HDMI video input for this source.

■ **Component:** the unit is forced to use the COMPONENT/RGB video input for this source.

■ **S-Video:** the unit is forced to use the S-VIDEO input for this source.

■ **Composite:** the unit is forced to use the COMPOSITE video input for this source.

Audio Source – Selects the particular connection type for each input. The default is HDMI; this setting must be changed if another connection is used.

Select from the list the audio type you are using on this source.

■ **HDMI:** the unit is forced to use the HDMI audio input for this source.

■ **Digital:** the unit is forced to use the optical (TOSLINK) or coaxial (S/PDIF) digital audio input for this source

■ **Analogue:** the unit is forced to use the analogue audio input for this source.

General Setup

General information and system controls.

Source Input – (Information only) The currently selected input to which the settings below relate.

Incoming Format – (Information only) The format of the digital audio stream connected to this input, if present.

Incoming Sample Rate – (Information only) The sample rate of the digital audio stream connected to this input, if present.

Incoming Bit Rate – (Information only) The bit rate of the digital audio stream connected to this input, if present.

Dialnorm – (Information only) If a Dolby Digital audio stream is connected to this input, this is the Dialogue Normalisation setting requested by the stream.

Video Input – The currently selected video input. For inputs that have video connections (e.g. SAT, PVR etc), audio and video inputs normally switch over together. However, here you can temporarily select a different video source for the current audio source. This feature may be useful, for example, if you are watching a sports game on satellite but on this occasion wish to listen to the commentary on the radio instead. This temporary override is reset when the input source is changed so

that the Video Input follows the Audio Input setting (or the setting in the Video Inputs menu, if applicable).

Audio Compression – Allows selection of compression which is ideal for late night listening. The compression effect increases the volume of the quiet passages and decreases the volume of the louder passages. Compression only applies to Dolby soundtrack formats that support this function (DTS is not supported).

■ **Off:** (default) no audio compression is applied.

■ **Medium:** compression is applied so that loud portions of a soundtrack are reduced in level.

■ **High:** the maximum amount of dynamic range compression is applied, so that the difference between loud and quiet portions of a soundtrack is minimised.

This setting applies to all inputs when a relevant digital audio stream is detected. It is stored in memory and recalled each time the unit is powered up.

Balance – To alter the sound balance temporarily between front left and right speakers. You can alter the sound stage to either the left or the right by up to 6dB. Note that it is not possible to shift the audio signal completely over to one channel. This function resets to equal left/right balance when the input is changed.

PLII Dimension –

PLII Centre Width –

PLII Panorama –

These allow the adjustment of the sound field for Dolby Pro Logic II Music mode decoding of two-channel sources. These settings apply to all inputs when PLII or PLIIx Music decoding is selected. The settings are stored in memory and recalled each time PLII or PLIIx Music mode is selected.

■ **PLII Dimension:** Allows the user gradually to adjust the sound field either towards the front or towards the rear. Settings range from -3 to +3. We recommend Dimension is set to 0 for normal use.

■ **PLII Centre Width:** Controls the centre image width. With Pro Logic decoding, dominant centre signals come only from the centre speaker. If no centre speaker is present, the decoder splits the centre signal equally to the left and right speakers to create a 'phantom' centre image. The Centre Width control allows variable adjustment of the centre image so it may be heard only from the centre speaker; only from the left/right speakers as a phantom image; or from all three front speakers to varying degrees. We recommend Centre Width is set to 3 for normal use.

■ **PLII Panorama:** Extends the front centre image to include the surround speakers for an exciting 'wrap-around' effect with side-wall imaging.

Digital Output Freq. – Sets the sampling frequency of the audio Analogue-to-Digital converter. This setting applies to all inputs when analogue audio is being processed (i.e. not Stereo Direct mode). It is stored in memory and recalled each time the unit is powered up.

Maximum Volume – Limits the maximum volume setting the system can be turned up to in the main zone. This is a useful feature to prevent accidental overdriving of low power-handling speakers (for example). It is stored in memory and recalled each time the unit is powered up.

Max On Volume – Limits the maximum volume the system operates in the main zone when it is switched on or comes out of Standby. The system comes on at this stored volume setting if the last used (possibly very loud) volume exceeds this value. It is stored in memory and recalled each time the unit is powered up.

Display on time – Sets the time that the front panel display remains illuminated after receiving a command. The default is always on.

Audio In iPod – If you have an iPod connected to the AVR400 using an Arcam irDock or rLead, this control allows you to set which audio input is used.

CEC Control – Enables or disables HDMI CEC control, a system that allows devices connected with HDMI to control other compatible connected devices.

ARC Control – Enables or disables the HDMI 1.4 Audio Return Channel. This allows for television sound to be sent back to the AVR400, via the "Display" input.

HDMI Audio To TV – Enables or disables the transmission of HDMI audio from the HDMI output connector. Enable this setting if you wish to be able to listen using your TV speakers.

RS232 Control – Enables or disables RS232 control, a system that allows control from various third-party home automation systems.

Auto Setup

Auto Speaker Setup of your loudspeakers and subwoofer (if present) is controlled by this menu. A full description of how Auto Speaker Setup works is given on page E-33. Remember to insert the calibration microphone into the **AUX** input on the front panel and position the

microphone at the listening position before running Auto Setup.

Run Auto Setup – Press OK (or ) on the remote to start Auto Speaker Setup. The process will generate test tones from the speakers and will typically take less than two minutes. The test tone generator will cycle round each speaker twice.

Accept Setup – When Auto Speaker Setup has completed without errors you can choose to accept or reject the settings

- **No:** The settings are not stored in memory.
- **Yes:** All the speaker settings (speakers present, type, distance, level and crossover frequency) are stored in the relevant sections of the Setup Menu and overwrite any previous settings.

Auto Setup Progress – Gives a summary of what Auto Speaker Setup is doing as it progresses, starting with which speaker is being tested.

- **Noise Level:** Checking noise level relative to each speaker and subwoofer.
- **Number of Speakers:** Speaker configuration is detected including the number of surround speakers and whether a subwoofer and center speaker are connected.
- **Speaker Distance:** Accurately detects the appropriate distance of each speaker position as well as the subwoofer with respect to the microphone position.
- **Speaker Level and Size:** The crossover is set based on each channel's signal handling capability and the subwoofer crossover is automatically set. The SPL (Sound Pressure Level) of each speaker is matched with respect to the microphone position.
- **Calculating EQ:** Data gathered from each of the speakers is being processed.
- **Completed Error:** A problem was detected with the speaker setup. See the descriptions for each of the individual speakers, below. Alternatively an invalid speaker configuration was detected.

**Front Left –
Centre –
Front Right –
Surr. Right –
Surr. Back Right –
Surr. Back Left –
Surr. Left –
Subwoofer –**

If the above speakers are correctly detected as present in your speaker configuration, their size (Small or Large), distance from the listening position and trim level (dB) will be displayed. Note that size does not apply to the subwoofer. Otherwise an error message will be displayed:

- **Not Present:** A speaker was not detected on this channel.

Crossover Freq. – The frequency at which Auto Speaker Setup determined is the best point to filter low frequency sounds away from Small speakers and into the subwoofer (or Large speakers if a subwoofer is not present).

NOTE

Auto calibration is possible only for a 7.1 or 5.1 speaker configuration. For other speaker configurations such as a 2.1 (stereo + subwoofer) setup, you must complete setup manually by referring to the guidelines below for Speaker Configuration, Speaker Distance and Speaker Levels.

Spkr Types

Settings for the types of loudspeaker you have connected in your configuration. These settings are applied to all audio inputs and are stored in memory and recalled each time the unit is powered up.

**Front Left / Right –
Centre –
Surr. Left / Right –
Surr. Back L / R –**

Here you set the type of speakers that you have connected to your AVR400:

- **Large:** capable of full frequency range reproduction
- **Small:** not capable of full frequency range reproduction at the low frequency end
- **None:** speaker not present in your configuration

- **Subwoofer:** Set whether a subwoofer is present or not.

NOTE

It is not possible to set all speakers to Small unless there is a subwoofer in your speaker configuration. If you do not have a subwoofer, you will be forced to set your front speakers to Large.

Crossover Freq – This is the frequency at which loudspeakers set as Small start to redirect bass signals to the Subwoofer or Large speakers in your system. Small speakers redirect bass to the subwoofer, if present. The exception is the Centre speaker which, if Small, redirects its bass to front left/right provided that they themselves are Large. This is done to help keep Centre bass directly in front of the listening position.

MCH Sub Levels – This setting controls the subwoofer level from an externally decoded multi-channel source (BD-A, SACD, etc). Most BD players require a +10dB compensation on the subwoofer channel to maintain the correct balance with the main channels.

- **+10dB:** for normal BD players which output the analogue subwoofer channel at the low 0dB level. Gain compensation of +10dB is added to the subwoofer channel of the **MCH INPUT** in the AVR400.
- **0dB Normal:** for BD players which output the analogue subwoofer channel at the correct +10dB level. No subwoofer gain compensation is needed on the subwoofer channel of the **MCH INPUT** in the AVR400.

Use Channels 6+7 for – If your main zone speaker set up does not include Surround Back Left and Right speakers, you can choose to use the Surround Back amplifier channels to Bi-Amp the Front Left and Right pair, or as a stereo power amplifier for Zone 2.

Spkr Distance

Calibration settings for the distances between the loudspeakers and the listening position.

NOTE

Speakers that are not present in your configuration will be greyed out.

These settings are applied to all audio inputs and are stored in memory and recalled each time the unit is powered up.

Units – Select whether you wish to measure distances in imperial or metric units.

**Front Left –
Centre –
Front Right –
Surr. Right –
Surr. Back Right –
Surr. Back Left –
Surr. Left –
Subwoofer –**

As described in “essential setup” on page E-32, measure the distance from each loudspeaker in your system to your ear in the main listening position and enter the values. This allows the AVR400 to calculate the correct relative delay for each loudspeaker.





Spkr Levels

Calibration settings for the test noise signal level through the loudspeakers and measured at the listening position.

NOTE

Speakers that are not present in your configuration will be greyed out.

These settings are applied to all audio inputs and are stored in memory and recalled each time the unit is powered up.

Use the  and  navigation buttons on the remote control to select the relevant speaker. Press  to enable/disable the calibration noise and the  and  navigation buttons to adjust the noise level from each speaker.

**Front Left –
Centre –
Front Right –
Surr. Right –
Surr. Back Right –
Surr. Back Left –
Surr. Left –
Subwoofer –**

As described in “essential setup” on page E-32, adjust the level of the test noise from each speaker so that an SPL meter at the listening position measures 75dB SPL.

Video Inputs

Settings to optionally assign a video source to each of the normally audio-only inputs.

These settings are stored in memory and recalled each time the unit is powered up.

Video Input CD –

Video Input Aux –

Video Input AM / FM –

Video Input MCH –

Video Input iPod –

Video Input Net –

Video In Digital Radio –

The default for each of the audio inputs is 'None', however for example you could associate the satellite 'Sat' video with AM, FM and Digital Radio audio if you wished. This way you could listen to the FM or AM or Digital Radio commentary of a sports game but have the pictures from the satellite coverage.

Video Outputs

The settings in this menu control the output resolution from the video processor in the AVR400. These settings are applied to all video inputs and are stored in memory and recalled each time the unit is powered up.

NOTE

Important points to remember:

For the analogue output

You should set the frame rate (50Hz Interlaced for PAL, 60Hz Interlaced for NTSC) and the aspect ratio (4:3 standard or 16:9 widescreen) to match your display device.

For the HDMI output

The output resolution, frame rate and display aspect ratio can be automatically determined by the AVR400. Alternatively these settings can be manually selected.

Zone 1 OSD – Selects whether the main zone pop-up OSD messages are On or Off. It is stored in memory and recalled each time the unit is powered up.

- When **On**, all user adjustments that are made during the general use of the AVR400 are displayed on screen as well as the front panel display. This includes the adjustment of volume, subwoofer level, lip sync, tone controls, etc. It is stored in memory and recalled each time the unit is powered up.
- When **Off**, the above user adjustments will not appear on screen, only on the front panel display. This leaves the picture on your display device clear of pop-up text. However, regardless of this setting the Setup menus are always displayed on screen.

Zone 2 OSD – Selects whether the Zone 2 pop-up OSD messages are On or Off. It is stored in memory and recalled each time the unit is powered up.

Analogue Output – This setting controls the output resolution of the analogue video output of Zone 1. The dropdown list shows all the resolutions that the AVR400 video processor can output.

Analogue Frame Rate – This setting controls the output frame rate of the analogue video outputs of Zone 1. This setting is only valid if the HDMI output is not being used at the time. See the Note 'Important points to remember' regarding analogue frame rates.

Display Type – Set the aspect ratio of your display device; 4:3 standard or 16:9 widescreen.

HDMI Output Resolution – This setting controls the output resolution of the HDMI output.

- The dropdown list shows all the resolutions that the AVR400 video processor can output. Resolutions that are not supported by the connected display device are greyed out and cannot be selected.
- **Preferred:** sets the output resolution to be the preferred resolution that is requested by the display device. This is often the highest resolution the display device can receive.
- **Bypass:** this is a special mode where video passes straight through the AVR400 without alteration. Use this mode to watch 3D content on a 3D television. This mode also allows the AVR400 to output video with a 23.976Hz frame rate. The output resolution and frame rate will be identical to the input resolution and frame rate. The display must be capable of supporting the input resolution and frame rate — if the input video format is not supported by the display there will be no picture.

Output Frame Rate – This setting controls the output frame rate of the HDMI output.

- The dropdown list shows all the frame rates that the AVR400 video processor can output. Frame rates that are not supported by the connected display device at the above resolution are greyed out and cannot be selected.
- **Auto** sets the **HDMI OUT** frame rate to be the preferred frame rate that is requested by the display device for the currently used resolution.
- **Follow input** sets the **HDMI OUT** frame rate to be the same as the input frame rate. Use this setting if you regularly switch between 24Hz and 50/60Hz content and have a 24p compatible TV.

Lipsync – (Information only) Displays how much lip sync is automatically applied to the HDMI output to compensate for video processing delays in the attached display device. Not all display devices support this function.

Mode

Lists the decode and downmix options you wish to include when cycling through the options on the **MODE** button. Settings are Yes or No. The list is divided into two sections depending on the source audio type. See section "decoding modes" on page E-40 for more information on each processing and decoding mode.

These settings are applied to all audio inputs and are stored in memory and recalled each time the unit is powered up.

For Stereo sources:

Dolby ProLogic –

Dolby PLIIx Movie –

Dolby PLIIx Music –

Dolby PLIIx Game –

Neo:6 Cinema –

Neo:6 Music –

The first section, 'Stereo sources' is the list of processing modes you wish to make available for stereo signals (analogue stereo, digital PCM stereo, Dolby 2.0, DTS 2.0, etc). When a stereo signal is applied, each press of the **MODE** button cycles through the processing modes you have enabled in the 'Stereo sources' section. The unprocessed Stereo option is always available for stereo signals therefore it is not shown in the list.

For Multi-channel sources:

Stereo Downmix –

Dolby Digital EX –

Dolby PLIIx Movie –

Dolby PLIIx Music –

The second section, 'Multi-channel sources' is the list of processing modes you wish to make available for multi-channel digital signals (any Dolby or DTS digital stream that has more channels than stereo 2.0). When a multi-channel digital signal is applied, each press of the **MODE** button cycles through the processing modes you have enabled in the 'Multi-channel sources' section.

Zone Settings

Lists the volume and control settings for Zone 2. These settings are applied to all audio inputs and are stored in memory and recalled each time the unit is powered up.

Z2 Input – Selects the analogue audio and composite video source to be routed to Zone 2. The default is 'Follow Z1', i.e. the same source as currently selected in Zone 1.

Zone 2 Status – displays whether Zone 2 is in Standby or On, for information only.

Zone 2 Volume – The current volume in Zone 2.

Zone 2 Max. Vol – Limits the maximum volume setting the system can be turned up to in the Zone 2. This is a useful feature to prevent accidental overdriving of low power-handling speakers, for example.

Zone 2 Fixed Vol – The Zone 2 volume control can be locked at the current value for use with an external amplifier with its own volume control in Zone 2.

Zone 2 Max On Vol – Limits the maximum volume the system operates in the Zone 2 when it is switched on or comes out of Standby. The system comes on at this volume if the last used (possibly very loud) volume exceeds this value.

Zone 2 format – Selects the video format used for the Zone 2 composite video output. PAL is mostly used in Europe and NTSC is mostly used in North America. This setting should only be changed if there is an unstable OSD on the Zone 2 display.

Network

The AVR400 is fitted with a network audio client which is capable of playing internet radio stations as well as stored music on a network storage device such as a PC, or on a USB flash drive.

Use DHCP – Select if your network uses DHCP

- **No:** To assign a fixed IP address manually.
- **Yes:** To use network parameters given by the DHCP server.

IP Address – If not using DHCP, enter the IP address you have assigned to the AVR400 for your network.

Subnet Mask – If not using DHCP, enter the subnet mask for the AVR400 on your network.

Gateway – If not using DHCP, enter the IP address of the router the AVR400 is connected to.

Primary DNS – If not using DHCP, enter the Primary DNS IP address of your internet service provider.

Alternate DNS – If not using DHCP, enter the Secondary DNS IP address of your internet service provider.

MAC address – (Information only) The unique address of the network card in your AVR400.

decoding modes

Introduction

Your AVR400 receiver provides all the key decoding and processing modes for analogue and digital signals, including the latest high definition audio formats over HDMI.

Modes for digital sources

Digital recordings are usually encoded to include information about their format type. The AVR400 detects automatically the relevant format in a digital signal – such as Dolby TrueHD, Dolby Digital Plus, DTS-HD Master Audio, Dolby Digital, or DTS – and switches in the appropriate decoding.

Modes for analogue sources

Analogue recordings do not contain information about their encoding formats, so the desired mode – such as Dolby Pro Logic – needs to be selected manually.

Mode memory

Dolby Digital or DTS audio (including the high definition formats) can be output in two mix modes, selected using the **MODE** button:

- Surround (e.g., five main channels plus a subwoofer for a 5.1 source)
- Stereo downmix.

Two-channel audio, regardless of whether it is analogue or digital can also be output in two mix modes, selected using the mode button:

- Surround (e.g., Dolby Pro Logic II Movie, Neo:6 Music, etc.)
- Stereo.

The AVR400 stores the settings for each source (except MCH). Thus the decoding mode for the following groups of source material can be stored independently:

- Dolby Digital (multi-channel) and DTS source material
- Two channel Dolby, PCM or Analogue source material

Two-channel source modes

The following decoding and surround modes are available for standard and high definition Dolby Digital 2.0, DTS 2.0, PCM or analogue sources:

Stereo

Pro Logic II Movie

Pro Logic II Music

Pro Logic II Game

Pro Logic IIx Movie

Pro Logic IIx Music

Pro Logic IIx Game

Pro Logic

Neo:6 Cinema

Neo:6 Music

NOTE

Pro Logic IIx modes are only selectable when Surround Back speakers are present.

Stereo

In this mode the AVR400 works as a conventional high quality audio amplifier. Note that if the subwoofer is enabled in stereo mode, then some processing of the signal will be carried out. To achieve ultimate sound quality with analogue sources, select the Stereo Direct function if an analogue connection is present.

Dolby Pro Logic II

Dolby Pro Logic II decoding is designed to produce five-channel output from two-channel source material.

There are three different modes available in Pro Logic II: 'Movie', 'Music' and 'Game' modes, which are intended for use as their names suggest. Due to the different recording methods used for movies, music and video games, it is recommended that the correct decoding mode for your source material is used to obtain best results.

- **Movie mode:** This is intended for use with 'cinematic' material, which is mixed and monitored in a calibrated multi-channel environment. Movie mode is a 'fixed' mode that is designed to give a similar sound when listening using a home cinema system to that obtained in a cinema.
- **Music mode:** Stereo music is not designed for surround processing, although good surround effects can be obtained through careful production.

As the optimum decoding method varies according to the recording, Music mode allows the user adjustment of the processing characteristics.

- **Game mode:** Video games today are extremely sophisticated, with dramatic 5.1 surround audio tracks. Game mode gives augmented bass management to capture the full effect of game sounds panned to the surrounds, ensuring the bass impact from purer surround effects are fully delivered to the subwoofer.

Dolby Pro Logic IIx

Dolby Pro Logic IIx is an extension of the Dolby Pro Logic matrix-decoding method. The decoder allows the processor to derive seven outputs from a two or multi-channel (up to 5.1 with EX) source to take better advantage of all amplifiers and speakers in a 7.1 setup. As with Pro Logic, there are three different modes available: Movie, Music and Game. Due to different recording methods used for movies and music, you should select the correct mode for your source material.

Dolby Pro Logic

Dolby Pro Logic is a legacy mode that is designed to produce a five-channel output from two-channel source material. It should be used only when the source material is encoded as Dolby Pro Logic; otherwise, we recommend the use of Dolby Pro Logic II. This is because Pro Logic processing on straight stereo sources can sound muffled and compressed.

DTS Neo:6

DTS Neo:6 provides up to six full-band channels of decoding from stereo material. The AVR400 will derive separate channels corresponding to the standard home theatre layout.

- **Cinema:** A movie mode designed to reproduce a movie theatre environment. Neo:6 technology allows various sound elements within a channel or channels to be steered separately, and in a way which follows the original presentation naturally.
- **Music:** A music mode designed to produce a lively, high-integrity surround-effect from most two-channel music sources from all available speakers. Neo:6 music mode expands stereo recordings into the five or six-channel layout without diminishing the subtlety and integrity of the original stereo recording.

Multi-channel source modes

Digital multi-channel source material is normally provided as '5.1 audio'. The '5.1 channels' comprise of: left, centre and right front speakers, two surround speakers and a low frequency effects (LFE) channel. Since the LFE channel is not a full range channel, it is referred to as '.1'.

Surround systems decode and reproduce the 5.1 channels directly. Dolby Digital EX and DTS-ES matrix enhanced decoding systems create one extra rear channel from information buried in the two surround signals of the 5.1 source. These EX and ES enhanced systems are sometimes referred to as '6.1' systems. This extra surround back channel is normally reproduced through two separate loudspeakers, creating a '7.1' system.

DTS-ES discrete is a true '6.1' source, with six discretely encoded channels, plus the '.1' LFE channel.

Dolby Digital Plus, Dolby TrueHD and DTS-HD are high-resolution surround formats found on Blu-Ray discs

Decoding modes

The modes given in the following table are available for multi-channel digital sources.

Special modes such as DTS-ES 6.1 discrete, Dolby Digital Plus, Dolby TrueHD and DTS-HD are only available from the correct source material.

High resolution audio sources	
Dolby TrueHD	Provides up to 7.1 full channel at 96kHz, 24bit resolution, with potentially no losses in the compression process. Data rates can be up to 18Mbps.
Dolby Digital Plus	Provides up to 7.1 discrete channels of audio with less compression than traditional Dolby Digital encoding. Data rates can be up to 6Mbps.
DTS-HD Master Audio	Provides up to 7.1 full channel at 96kHz, 24bit resolution, with potentially no losses in the compression process. Data rates can be up to 24.5Mbps.
For Dolby Digital sources	
Dolby Digital 5.1	The most commonly used sound format for DVD video, and is also the standard for US television. Dolby Digital 5.1 sources deliver sound with five discrete full-range channels; left, centre, right, surround left, surround right, plus a low frequency effects (LFE) channel.
Dolby Digital 5.1 Stereo Downmix	Provides a stereo downmix of the source material for use with headphones.
Dolby Digital EX	This is an extension to Dolby Digital decoding that provides a 6-channel output from a 5-channel input. The extra channel is the centre-surround channel (for which the two surround back speakers are used), and is derived from the left and right surround channel information. This decode mode should be used only when the source material is 'Surround EX' encoded (which is normally indicated on the disc packaging and should be detected automatically by the AVR400), but may be used at other times if desired.
Dolby Digital 5.1 + Pro Logic IIX Movie	This mode is used to derive information for the individual surround back channels from the surround channels, using the Pro Logic IIX Movie decoder.
Dolby Digital 5.1 + Pro Logic IIX Music	This mode is used to derive information for the individual surround back channels from the surround channels, using the Pro Logic IIX Music decoder. The controls for adjusting Pro Logic IIX Music in 'General Setup' can be used in this mode.
For DTS sources	
DTS 5.1	Less common than the Dolby Digital format, but generally recognised within the audio industry as being of superior sound quality. DTS 5.1 delivers surround sound with five full range channels plus an LFE channel.
DTS 5.1 Stereo Downmix	Provides a stereo downmix of the source material for use with headphones.
DTS-ES 6.1 Matrix	This is a 6.1 channel format based on DTS 5.1. It has the sixth channel matrix encoded into the surround left and surround right channels. The sixth channel is a surround centre channel and is directed to the surround back left and surround back right speakers.
DTS-ES 6.1 Discrete	This is a true discrete 6.1 channel sound format (unlike DTS-ES Matrix). DTS-ES discrete mode operates only on sources with DTS-ES 6.1 discrete audio encoding.
DTS96/24	Provides up to 5.1 channels of audio at 96kHz, 24bit resolution for superior sound quality compared to standard DTS 5.1

Dolby volume



Dolby Volume is a sophisticated new technology that resolves the problem of different volume levels between programme content (e.g. a TV show and advert breaks) and between sources (e.g. a rock radio station and DVD, or between two TV stations). It lets the listener enjoy everything at the same preferred listening level without having to reach for the volume control to compensate for the different recording/output levels. This is the Volume Leveller function of Dolby Volume.

Dolby Volume also works in conjunction with the AVR400 volume control setting to compensate for the ear's changing sensitivity at different frequencies depending on how loud the audio is. It is based on a model of how human hearing works. It properly balances low, mid and high frequencies to maintain all the nuances and impact of the original audio regardless of the actual selected playback volume level. This is the Volume Modeller function of Dolby Volume.

Dolby Volume measures, analyses and maintains volume levels based on how people perceive sound. A variety of audio parameters are monitored including spectral- and time-based loudness to ensure that perceived dynamics, timbre and bass performance remain consistent at all volume levels.

Dolby Volume also lets the listener control a programme's dynamic range – the range between loud and quiet sounds. For example, with the volume turned down for late-night viewing, dynamic range can be adjusted so that speech remains clear and loud effects or music passages retain their impact without waking up the family.

Settings

Dolby Volume can be applied to any analogue or digital stereo source or any digital multi-channel source. *It is not available in Stereo Direct or on the analogue multi-channel input.* Dolby Volume can even be applied to processing of stereo signals (e.g. PLII Music) or when down-mixing a digital multi-channel source (e.g. Dolby Digital 5.1 down to stereo).

Dolby Volume can be enabled and configured separately for each audio input in the Input Config menu. The default is 'Off' for 'audiophile' listening. You may wish to turn Dolby Volume 'On' for TV and movie sources to maintain the same perceived overall listening level

between sources and frequency response regardless of the volume setting. Most of the controlling parameters of Dolby Volume are automatic as they are dependent on analysis of the audio signal and the volume setting of the AVR400. However, the Volume Leveller and Calibration Offset controls (see below) can be adjusted to your preference.

Volume Leveller

The Volume Leveller function of Dolby Volume controls how closely quiet and loud sources and programme content are matched to each other, based on the ear's perception of loudness. The range of values is 0 (minimal levelling) to 10 (maximum levelling). The default setting is 2. If the Volume Leveller function is turned off, no level matching between sources and programme material is performed. This is not the same as turning Dolby Volume off as volume related frequency response processing is still active.

When Dolby Volume is being applied to the current input, a Dolby Volume processing mode indicator is shown on the OSD and the front panel display.

Calibration Offset

The Calibration Offset parameter of Dolby Volume allows you to compensate for speaker efficiencies and listening position – effectively moving the reference listening level up or down the volume scale. The default value is 0 and this should normally produce a good result when the AVR400 speaker levels are set using a sound pressure level meter at the listening position (75dB SPL, 'C' weighting, slow response).

tuner operation

The AVR400 is fitted with an internal AM/FM tuner and a DAB (digital radio) tuner. DAB broadcasts are not available in all locations.

This section deals with tuner operation, for information on setting up the tuner and installing aerials, see page E-16.

When a tuner input is selected, the OSD shows a list of radio presets plus an information panel giving all available information about the current frequency (for AM and FM) or station (for DAB).

The front panel will also give the same information, pressing the INFO key will cycle through the various items of information:

AM
<ul style="list-style-type: none">• Processing mode (default)• Frequency• Signal strength
FM
<ul style="list-style-type: none">• Processing mode (default)• Radiotext (if available)• Programme type (if available)• Signal strength
DAB
<ul style="list-style-type: none">• Processing mode (default)• Radiotext (if available)• Programme type• Signal quality• Bit-rate of transmission

Tuning/Channel Selection

When switching to the internal TUNER source, the AVR400 enters the last used tuner band, be it AM / FM / DAB (if fitted). Repeatedly pressing **TUN** cycles through the available tuner bands on your AVR400.

FM/AM analogue radio

Frequency tuning on FM and AM radio is done using the **◀** and **▶** buttons on the CR102 remote control in TUN device mode. Individual presses move the frequency down and up one step. If you press and hold either of the tuning buttons for two seconds, the tuner scans to

the next strong signal. You can stop a scan at any time by pressing one of the tuning buttons again.

In Europe, the internal FM radio is capable of receiving RDS (Radio Data System) radiotext signals that are transmitted on some stations. The RDS information typically includes the radio station name, the music or speech genre as well as additional information related to the current programme. On music stations this is often information on the currently playing track.

DAB digital radio

If your AVR400 is fitted with the optional DAB tuner you will need to scan for available stations before being able to listen to them.

To scan for DAB stations, first select the DAB tuner then press and hold **OK** until the display indicates scanning has started. The AVR400 will then scan all the DAB radio frequencies and compile a list of the stations that are available.

When the scan is complete, you can scroll through the station list using the **◀** and **▶** buttons on the CR102 remote control. To listen to the currently displayed station press the **OK**. If you do not press **OK** within two seconds, the display will revert to displaying the currently playing station.

Internet radio

Please see the Network/USB Operation section on page E-45 for details of internet radio operation.

Saving and selecting Presets

Preset selection uses the **▶** and **◀** keys on the remote to browse and **OK** to select the preset when the CR102 is in TUN device mode.

Up to 50 presets can be stored and these can be from any band, for example Preset 1 could be an AM station, preset two a DAB station, etc. Pressing the OK key causes the next available preset number to be displayed, then pressing the OK key again stores the current frequency/channel in that preset. If a different preset number is required, press the **▶** or **◀** keys until the desired number is displayed before pressing the OK key for a second time.

Deleting Presets

When in tuner browse mode (using **▶** and **◀** to scroll through the presets), the yellow button on the CR102 remote is used to delete the currently highlighted (but not playing) station or frequency.

network/usb operation

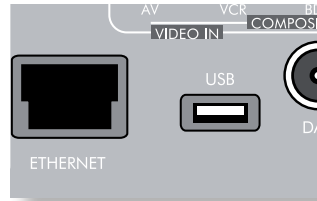

The AVR400 is fitted with a network audio client which is capable of playing internet radio stations as well as stored music on a network storage device such as a PC, or from a USB flash drive.

For information on installing the AVR400 on your network, see page E-17.

The AVR400 supports the following file formats:

- MP3
- WMA (Windows Media Audio)
- WAV
- FLAC (Free Lossless Audio CODEC)
- MPEG-4 AAC (iTunes) with DRM10 support

Favourites

You can store internet radio stations in your 'favourites' folder for easy access later. Once playing, pressing the FAV+ key adds the track to the 'favourites' folder. Pressing FAV- removes the station from the 'favourites' folder (this key only has an effect if the station is in the favourites folder).

NOTE

For playback from a network device, the network device needs to be running a universal plug and play (uPnP) service, such as Windows Media Player 11. This can be downloaded free of charge from www.microsoft.com or installed via the Windows update installer. Windows 7 and Vista™ have this functionality built in. Windows Media Player requires music library sharing/streaming to be enabled in order to serve music to the AVR400.

Other free and paid-for uPnP services are available for other computer operating systems. Some network attached storage (NAS) systems include a built-in version of a uPnP service.

Selecting the playback source

Selecting the network client will allow playback of internet radio stations and stored music on a networked storage device or USB memory device.

To select the network source the CR102 remote must first be in AMP device mode (press **AMP**). Then press **SHIFT** + **iPOD** on the remote to select the Network source. You can also cycle to it using the **-INPUT / INPUT+** keys on the front panel.

The 'home' page has options for playing audio from a USB device, Internet Radio or from your home network using the 'Music Player' option. Navigate through these items using the **▲**, **▼**, **◀** and **▶** keys. Folders that may contain playable files have a **📁** symbol, playable files have a **🎵** symbol. Once you reach the track you wish to play, press **OK** key.

Once playing, pressing **⏸** will pause the track (except Internet Radio).

Pressing the **⏩** key skips forward one track. If the last track is reached the key is ignored.

Pressing the **⏪** key skips back one track. If the first track is reached, the key is ignored.

Pressing the **RND** key on the remote plays the tracks in the current folder in a random order.

Pressing the **REP** key on the remote repeats all the files in the current folder. Pressing it again cancels the repeat function.

USB playback

Insert a USB device into the socket on the AVR400 and select the network client input. The USB device appears in the list of folders that can be navigated. Highlight it using the **▲** and **▼** keys and press **▶** to navigate the contents of the USB device. Navigate through folders **📁** (using the **▲**, **▼**, **◀** and **▶** keys) to a music file **🎵** and press the **OK** key to play the file.

Internet radio stations

Although you can manually browse for an internet radio station, the AVR400 uses the vTuner service to allow easy selection of favourite internet radio stations and podcasts. To set up this service for your AVR400, please visit www.arcamradio.co.uk

There, you will be asked to enter the Media Access Controller (MAC) address which is the unique ID of your AVR400. This MAC address can be found in the network section of the setup menu.

Once you have entered the MAC address, you can then browse stations and podcasts and set up groups of favourite stations. When you next connect your AVR400 to the internet, these groups will appear in the 'My favourites' folder.

Pressing the **INFO** key will cycle what is shown on the lower portion of the front panel display between:

- Elapsed Time (default)
- Processing mode
- Album (if available)
- Artist (if available)
- File information (bitrate, type).

iPod

It is possible to connect an iPod to your AVR400 using either the Arcam **rLead** or **irDock** accessories (please contact your dealer).

Connect the 9-way plug into the socket marked 'irDock' and the audio leads to the VCR input (the iPod input can be changed in the General Setup menu). If your iPod has video output and you are using the **irDock**, connect the composite and S-Video leads to the VCR video inputs.

To select the iPod input, press the **iPOD** key on the remote while in **AMP** Device Mode, or cycle to it using the **-INPUT / INPUT+** keys on the front panel. Find songs to play by navigating through Artists, Albums etc. using the **▲**, **▼**, **◀** and **▶** keys.

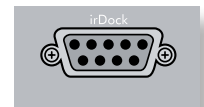

multi-room set up

The AVR400 allows independent routing and control of analogue audio and Composite video to a separate set of equipment, typically used for a second living space, e.g., bedroom or lounge.

The connection guide on the following page shows how the AVR400 is normally connected in a multi-room installation.

Zone 2

Zone 2 receives only signals obtained by the AVR400 from the analogue audio and Composite video inputs. The analogue inputs are required because there is no analogue-to-digital, digital-to-analogue or DSP processing available for Zone 2 signals – the AVR400 only converts video formats for Zone 1.

For this reason, we recommend that in addition to any digital connections, the analogue audio and Composite video outputs from your source devices are connected to the AVR400.

Video outputs

The Z2 Composite video output connectors of the AVR400 should be connected to the analogue video inputs (usually labelled **VIDEO IN** or **COMPOSITE VIDEO IN**) of the display device in Zone 2.

Audio outputs

The Z2 **OUT, R** and **L** phono sockets should be connected to the analogue audio inputs (Usually labelled **ANALOGUE AUDIO IN**) of the Zone 2 display device, or to the inputs of an additional stereo power amplifier in Zone 2 (for example, the Arcam P38).

Speaker outputs

If the main zone has a 5.1-channel surround sound speaker system (not a 7.1-channel system), the spare SBL and SBR speaker outputs can be used to power speakers in Zone 2, so that a power amplifier is not required. To configure the outputs, navigate to the “Spkr Types” option in the Setup Menu and set the option “Use Channels 6+7 for” to “Zone 2” (see page E-32).

Zone 2 control connections

The AVR400 also allows remote control from Zone 2.

Z2 IR

This allows the AVR400 to be controlled remotely from Zone 2 via Infra-red remote control. Connect a remote IR receiver in Zone 2 to allow control of the AVR400 from this listening/viewing area.



For more information on remote IR receivers, see ‘Z1 IR’ on page E-17.

TRIG Z2

This allows the AVR400 to remotely switch on devices in Zone 2 when Zone 2 is selected. For example you could set your television in Zone 2 to switch on when ‘Zone 2’ is selected on AVR400.

For more information on triggers, see ‘Trigger connectors’ on page E-17. Please note that not all AV devices have this feature, nor are triggers essential for listening and viewing in a separate zone.

Multi-room connection guide

Zone 1

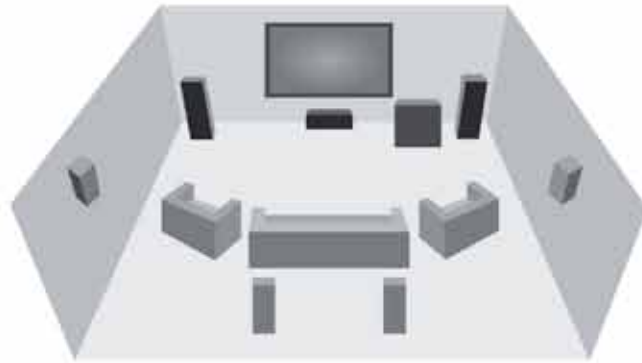

Zone 2

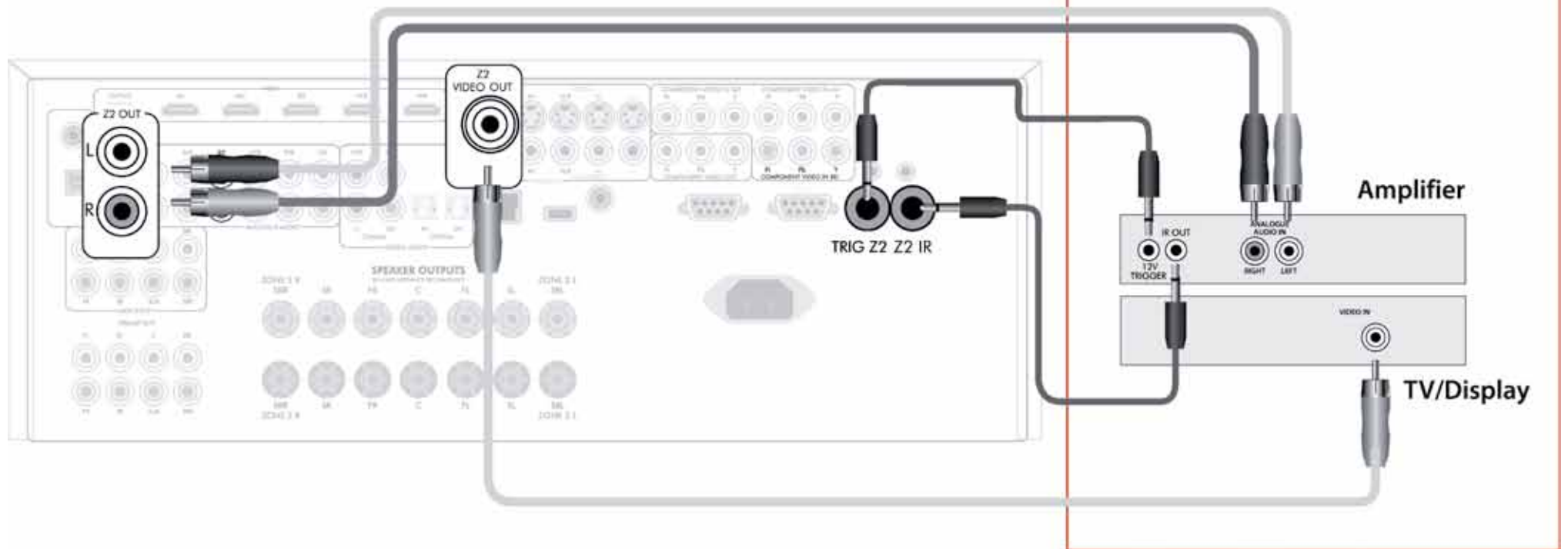

customising the CR102

Code Learning

The CR102 comes with a complete library of preprogrammed codes. After you have set up the CR102 for your device, you may find that there are one or more functions on your original remote which do not have a place on the CR102 keypad. For convenience, the CR102 offers a Code Learning feature that allows you to copy up to 16 functions from an original remote control onto the CR102 keypad.

Before you start, make sure that:

- The original remote control is working correctly.
- The remotes are not pointing at your device.
- The remotes have new batteries.
- The remotes are not in direct sunlight or under strong fluorescent lights.

Learned functions are mode-dependent: You could theoretically assign up to eight different functions to a single key (the CR102 can handle a total of 16 learned functions).

Example: To copy the 'text hold' function from a TV remote onto the **▶▶** key of your CR102

1. Place both remotes on a flat surface, 2 to 5cm apart, with the IR ports facing each other.
2. On the CR102, press and hold **SHIFT** until the power LED blinks twice: ✨ ✨.
3. Press **9** **7** **5**. The power LED blinks twice: ✨ ✨.
4. On the CR102, press the device key that matches the 'source' device (e.g. if you're learning a TV function, press **AV**).
5. On the CR102, press the key to which you want to assign the learned function (e.g. **▶▶**). The device key blinks rapidly.
6. On the original remote, press and hold the function key that you want to learn (e.g. **TEXT HOLD**) until the CR102 device key blinks twice: ✨ ✨.
7. If you want to learn other functions from the same source device, simply repeat steps 5 and 6 pressing the next key you want to learn.
8. To exit Code Learning mode, press and hold **SHIFT** until the device key blinks twice: ✨ ✨.

9. To use the learned function on the CR102, press the Device Mode key, followed by the function key.

In this example, you'd press **AV** followed by **▶▶**

Shifted Learning

You can assign a learned function to a CR102 key without sacrificing its original function.

You can assign Shifted Learning functions to any key **except** for: Device Mode keys (e.g. **AV**), **SHIFT**, or number keys (**0** to **9**).

1. To assign a Shifted Learning function, simply follow Code Learning steps in the previous section. During step 5, press **SHIFT** once before you press the key to which you want to assign the learned function.
2. To access the shifted function, press **SHIFT** and then the target key.

Important notes

- Once you start a Code Learning session, you have approximately 10 seconds to conduct each step. Any longer, and a timeout means that you'll have to start the process again.
- The Learning feature is mode-specific – you can copy one feature *per mode* onto a key.
- The CR102 can learn approximately 16 functions in total.
- To replace a learned function, simply assign a new one to the same key.
- Learned functions *are* retained when you change batteries.
- If Code Learning fails, try altering the distance between the two remotes; make sure that the light in the area is not too bright.

To delete a learned function

1. Press and hold **SHIFT** until the power LED blinks twice: ✨ ✨.
2. Press **9** **7** **6**. The power LED blinks twice: ✨ ✨.
3. Press a Device Mode key once. For example, if you want to delete one of your learned TV functions, press **AV**.
4. Press twice on the key you want to deassign. The handset blinks twice: ✨ ✨ to confirm.

The original function of the CR102 is restored.

To delete a Shifted Learned function:

To delete a Shifted Learned function, press **SHIFT** before you press the key to be deassigned (during step 4 above).

To delete ALL learned functions within a given Device Mode

1. Press and hold **SHIFT** until the power LED blinks twice: ✨ ✨.
2. Press **9** **7** **6** – the power LED blinks twice: ✨ ✨.
3. Press the appropriate Device Mode key twice.



Creating Macros

You can program your CR102 to issue a sequence of commands when you press a single key. Any sequence of commands you regularly use can be reduced to a single key press for your convenience.

For example, you might want to turn off your TV, VCR and Satellite at the same time.

- A key programmed with a Macro is available in all modes; it will replace that key's different functions for all modes.
- A Macro can consist of up to eight key presses.



Example: To assign a Macro to the **(SRCH)** key

1. Press and hold **(SHIFT)** until the power LED blinks twice: 
2. Press **(9) (9) (5)**.
3. Press **(SRCH)** (the Macro will be assigned to this key).
4. Press **(AV), (VCR), (SAT), (VCR)**. (These are the Macro steps you wish to record.)
5. To store the Macro, press and hold **(SHIFT)** until the power LED blinks twice: 

Now, whenever you press **(SRCH)**, the CR102 will toggle the power to your TV, VCR and Satellite.

- The important word here is 'toggle'. For example, if the TV and Satellite devices are currently on, but the VCR is off, pressing **(SRCH)** will switch off the TV and Satellite and switch on the VCR (rather than switching all three devices on or off).
- When using Macros, remember that you may need to change mode or use **(SHIFT)**, and that each key press (including changing modes and pressing **(SHIFT)**) counts as one of the Macro steps. You cannot use a Macro key within another Macro.
- If the amount of memory storage for a particular Macro is exceeded, the power LED comes on for five seconds. You can, however, save the macro steps up to that point by pressing **(SHIFT)**, or you can cancel the Macro recording by pressing any other key.
- The delay between key presses is recorded as part of the Macro. A delay of up to 30 seconds is permitted.

Example: To deassign the Macro associated with the **(SRCH)** key

1. Press and hold **(SHIFT)** until the power LED blinks twice: 
2. Press **(9) (9) (5)**.
3. Press **(SRCH)**.
4. Press and hold **(SHIFT)** until the power LED blinks twice: 

Volume punch-through

Volume punch-through means that, no matter which Device Mode is selected, the CR102 controls the AVR400 volume. You don't need to press **(AMP)** on your CR102; this feature is switched on by default.



There are times, however, when you might want to control a device's volume directly when in a specific Device Mode.

Example: To cancel volume punch-through for a TV (AV mode)

1. Press **(AV)** once.
2. Press and hold **(SHIFT)** until the power LED blinks twice: 
3. Press **(9) (9) (3)**.
4. Press **(-)**. The power LED blinks four times.



Now, while in TV (AV) mode, you will be able to control the volume or mute functions of your TV directly.

To completely cancel all volume punch-through settings

1. Press and hold **(SHIFT)** until the power LED blinks twice: 
2. Press **(9) (9) (3)**.
3. Press **(+)**. The power LED blinks four times 

Now, whichever mode you're in, you will have direct access to that device's volume or mute functions, assuming they are available. You would need to switch to **(AMP)** mode to alter the AVR400 volume.

Example: To restore default volume punch-through settings to all Device Modes

1. Press and hold **(SHIFT)** until the power LED blinks twice: 
2. Press **(9) (9) (3)**.
3. Press **(AMP)**. The power key LED blinks twice: 

Key Mover

Sometimes you might find that a key you use a lot for your system is in the 'wrong' place on the CR102 keypad for your comfort. It's quite easy to reassign a favourite function to a more accessible key. It is even possible to move a function from one Device Mode to another Device Mode.

Example: To assign the **(DISP)** function to the **(MENU)** key in SAT mode

1. Press **(SAT)**.
2. Press and hold **(SHIFT)** until the power LED blinks twice: 
3. Press **(9) (9) (4)**.
4. Press the key you want to move (e.g. **(DISP)**).
5. Press the key you want to move the key to (e.g. **(MENU)**).

Now, pressing either **(DISP)** or **(MENU)** while in SAT Device Mode makes the CR102 transmit the **(DISP)** function.

To completely swap over the functionality of the two keys to put the **(MENU)** functionality on the **(DISP)** key, repeat the above process again, but swap over the **(DISP)** and **(MENU)** key presses in the example.

Note that the function that is copied over to the new key is always the original function of the old key.

Restore a moved key

To restore a key to its previous function, repeat the example above, pressing the key to be restored twice (copy it back to itself).











Restore all moved keys for a Device Mode

To restore all keys in a Device Mode to their original functional positions, repeat the example above, but press the relevant Device Mode key (e.g. **(AMP)**) at points 1,4 and 5 in the example.

Copy a key between Device Modes

It is possible to copy functions between Device Modes. However, remember that button functions are Device Mode specific and therefore effectively 'punch-through' to the original Device Mode when copied over.

The following example copies the AVR400 **DIRECT** function from the CR102 **AMP** device mode to the shifted function of the  button on **AV** Device Mode.

1. Press and hold  until the power LED blinks twice:

2. Press   .
3. Press the Device Mode key of the function you want to move (e.g. .
4. Press the function key you want to move (e.g. /**DIRECT**)
5. Press the key of the Device Mode you want to copy the function to (e.g. .
6. Press the  button graphic
7. Press the key you want to copy the function to (e.g. .

If you prefer to copy the key to the main function of the  button instead of the 'shifted' function, omit point 6 in the above example.







Mode Mover



If your home entertainment setup contains devices of the same type (e.g. two TVs, perhaps from different manufacturers) you can still control both those devices with the CR102. You simply need to reassign an *unused* Device Mode key.

NOTE





Before using Mode Mover, make sure both the source and destination Device Mode keys are unlocked (see next section).

Example: To use the key to control a second TV

1. Press and hold  until the power LED blinks twice:

2. Press   .
3. Press the Device Mode key for the type of device you want to control (e.g. for a TV, press .
4. Press the Device Mode key you want to use (e.g. .
5. Don't forget to set up the CR102 to control the second device, using one of the methods on page E-25.

Note that volume punch-through is not applied to a Device Mode that has been copied using Mode Mover. However, AVR400 volume punch-through functionality can be restored when you have used Mode Mover, by copying ,  and  from the AMP Device Mode to the same physical buttons on the new moved Device Mode using the last example shown in Key Mover.

To restore a moved Device Mode key to its original state

1. Press and hold  until the power LED blinks twice:

2. Press   .
3. Press the Device Mode key you want to restore *twice*.

Locking/Unlocking a specific Device Mode

When you first unpack your CR102 and insert the batteries, for your convenience it is able to control certain Arcam components automatically (e.g. BD players, Amplifiers, Tuners and CD Players). We achieve this by preprogramming specific Arcam device codes onto the relevant Device Mode keys, then locking the Device Modes so you don't reprogram them inadvertently.

If you want to override these locked default settings – to control a third-party DVD player, for example – you will first need to unlock DVD Mode before setting up the CR102 using one of the methods described at the start of this guide.

Here are the factory default settings:

Device Mode	Default status	Default Arcam codes
DVD	Locked	0762
SAT	Unlocked	1205
AV	Unlocked	0586
TUN	Locked	2009
AMP	Locked	1242
PVR	Unlocked	1930
VCR	Unlocked	0111
CD	Locked	2010

Alternative codes are available for multi-room solutions, or in the case of code clashes with other manufacturer's products.

For example:







DVD (system code 12) 1655
AMP (system code 19) 1954

You will need to change the system code on the product you wish to control, as well as the CR102.

NOTE

The **AMP** Device Mode can only be used to control Arcam amplifiers like the AVR400, either on its default or alternative IR system codes.

To toggle a Device Mode lock setting:



1. Press the Device Mode key you want to unlock (e.g. .
 2. Press and hold  until the power LED blinks twice:

 3. Press   .
- The power LED blinks twice when being locked, and blinks four times when being unlocked.
 - If you enter an invalid key sequence, the power LED gives one long blink and returns to normal operation.

While the Device Mode key is locked, the Direct Code Setup and Move Mode functions are not available.

Mode key IR punch-through



The Mode key IR punch-through default is 'on'.

Example: To set the Mode key IR punch-through to AMP

1. Press and hold **SHIFT** until the power LED blinks twice:

2. Press **9 7 1**. The power LED blinks twice:

3. Press **AMP** to punch through IR from it.







Now, whenever you press and release a Mode key, the IR data assigned to **AMP** is transmitted, no matter what the current mode is (i.e. it 'punches through' any other device).

To cancel Mode key IR punch-through

1. Press and hold **SHIFT** until the power LED blinks twice:

2. Press **9 7 1**. The power LED blinks twice:

3. Press **SHIFT** until the power LED blinks twice:

Resetting the CR102



Resetting the CR102 will erase all learned functions across all modes, as well as some other programmed functions like Macros. It will not reset the Device Mode keys; these will remain programmed to your choice of component.

1. Press and hold **SHIFT** until the power LED blinks twice:

2. Press **9 8 0**. The power LED blinks four times:

3. Press and hold **SHIFT** until the power LED blinks twice:

4. Press **9 9 3**.
5. Press **AMP**. The power key LED blinks twice:

6. Press and hold **SHIFT** until the power LED blinks twice:

7. Press **9 7 1**. The power LED blinks twice:

8. Press **AMP**. The power key LED blinks twice:

Command summary

Direct code setup

(e.g. AV mode, NNNN=code number)



AV **SHIFT**   NNNN   

Library search

(e.g. AV mode)

AV **SHIFT** **9 9 1**     until unit turns off
SHIFT to save

Code blink back

AV **SHIFT** **9 9 0**  

- ① count blinks for first *N*
- ② count blinks for second *N*
- ③ count blinks for third *N*
- ④ count blinks for fourth *N*

Code learning

(e.g. AV mode fast forward key)

SHIFT   **9 7 5**   **AV**    (many rapid blinks)

(Press key on original remote that you wish to copy)

  **SHIFT** 



Delete a learned function

(e.g. AV mode fast forward key)

SHIFT   **9 7 5**   **AV**   

Delete all learned functions with a device

(e.g. AV mode)



SHIFT   **9 7 5** **AV** **AV**

Creating macros

(e.g. SRCH key)



SHIFT   **9 9 5** **SRCH** **AV**  **VCR**  **SAT**  **SHIFT**

Deassign macro

SHIFT   **9 9 5** **SRCH** **SHIFT** 



Key mover

(e.g. SAT mode, DISP key to MENU key)

SAT **SHIFT**   **9 9 4** **DISP** **MENU**

Mode mover

(e.g. change SAT to TV(AV))

SHIFT   **9 9 2** **AV** **SAT**



Restore device mode

(e.g. restore SAT)





SHIFT   **9 9 2** **SAT** **SAT**

Locking/unlocking a mode

(e.g. DVD mode)



DVD **SHIFT**   **9 8 2** 

(i.e. two blinks for lock)

DVD **SHIFT**   **9 8 2**  

(i.e. four blinks for unlock)



Cancel all volume punch-through

SHIFT   **9 9 3** **+**  





Restore volume punch-through

SHIFT   **9 9 3** **AMP** 

Mode key IR punch-through

SHIFT   **9 7 1**  **AMP**

Cancel mode key IR punch-through

SHIFT   **9 7 1**  **SHIFT** 

NOTE

As elsewhere in this Handbook, a single 'blink' of the red LED behind the power button is indicated by the symbol .

trouble-shooting

Problem	Check that...
There are no lights on the unit	<ul style="list-style-type: none"> the power cord is plugged into the AVR400 and the mains socket it is plugged into is switched on. the power button is pressed in. <p>If a red LED is present, the AVR400 is in standby mode. Press any button on the front panel or remote control.</p>
The unit responds erratically or not at all to the remote control	<ul style="list-style-type: none"> there are fresh batteries in the remote control. the front panel window is visible and you are pointing the remote control towards it.
The front panel display is blank	<ul style="list-style-type: none"> the display hasn't been turned off. Press the DISPLAY button on the front panel or remote control.
No picture is being produced	<ul style="list-style-type: none"> your viewing device is turned on and switched to display your AVR400. Test by pressing the MENU button on the AVR400 or on the remote and look for the main menu screen on your display device. the correct video input is selected on the AVR400. the "Video Source" has been set correctly in the "Input Config." menu the video source is on, is operating normally, and is in 'play' mode if appropriate. you have the AVR400 in a video resolution that is compatible with the connection you are using and with your display device. For example, composite video is only capable of carrying 480i and 576i resolutions. Test this by pressing and holding the OK key for more than two seconds to force 480i / 576i output resolutions.
There are bright edges or 'ghosts' on the picture	<ul style="list-style-type: none"> the cables used for analogue video connections are designed to carry video (i.e., they are 75Ω coaxial cables). ensure the 'sharpness' control on your display device is switched off or set to near minimum. for HDMI connections, try using a shorter cable or alternatively a different brand.
No sound is produced	<ul style="list-style-type: none"> the correct input has been selected. the "Audio Source" has been set correctly in the "Input Config." menu the source equipment is on, is operating normally and is in 'play' mode if appropriate. the volume is turned up to a reasonable level and the AVR400 is not in mute mode.
The sound is poor or distorted	<ul style="list-style-type: none"> you have not excessively increased the input sensitivity (i.e. reduced the maximum input signal voltage) in the Input Config. menu if an analogue input is being used. you have selected the correct size of speakers to suit your system in the setup menu.

Problem	Check that...
Sound only comes from some of the speakers	<ul style="list-style-type: none"> ■ you have an appropriate surround source selected and playing. ■ the BD/DVD disc is encoded in the appropriate format, and the correct format has been selected in the disc start menu of the BD player (if applicable). ■ the BD/DVD player has been set to output 'bitstream' audio on the digital output. ■ the display window indicates that the disc you are playing is a multichannel recording (you may need to press the INFO key several times until you get to the 'incoming format' display). ■ all the speakers are correctly connected to the speaker terminals and are secure. ■ you have not selected 'Stereo' as the decoding mode. ■ your speaker balance is correct. ■ you have configured the AVR400 to include all the speakers in your system.
Unable to select Dolby Digital or DTS decoding modes	<p>The AVR400 can only apply Dolby Digital and DTS decoding to sources which have been encoded in the same format.</p> <p>Check that:</p> <ul style="list-style-type: none"> ■ digital source is selected and connected. ■ the source is playing appropriately encoded material. ■ the BD/DVD disc is encoded in the appropriate format and that the correct format has been selected in the disc start menu of the BD player (if applicable). ■ the BD/DVD player has been set to output 'bitstream' audio on the digital output.
When playing a Dolby Digital BD, the AVR400 selects Dolby Pro Logic	<ul style="list-style-type: none"> ■ you have a digital connection from your BD player. ■ sometimes Dolby Digital BD/DVD discs contain material at either the beginning or the end of the main movie that is not in full 5.1 format, but in two-channel or Pro Logic decoding.
Hum on the analogue input	<ul style="list-style-type: none"> ■ all cables are making a good connection. If necessary withdraw the cable from the connector and plug it fully in again (turn the power off before doing this). ■ the connections inside the source cable connector are not broken or badly soldered. ■ if the hum originates only when one particular source component is connected, that an aerial cable, or dish connection to this source is ground isolated. Contact your installation contractor.
There is radio or television reception interference	<ul style="list-style-type: none"> ■ where the interference is coming from. Switch off each source component in turn, then any other equipment. Most electronic equipment does generate low levels of interference. ■ try re-arranging cabling from the nuisance source away from other cabling. ■ ensure that the cabling used is high quality, specified for its purpose, and is properly screened. ■ if the problem persists, contact your dealer.

Problem	Check that...
The source switching changes randomly or freezes on one source	<ul style="list-style-type: none"> ■ there are no static or impulse interference problems caused by nearby power equipment switching, e.g., heating or air conditioning control. Switch the AVR400 off, wait ten seconds, then switch it on again to clear an operating problem. Contact your installer if the problem returns or persists. ■ there is no direct sunlight shining on the infra-red detector behind the front panel display.
Volume is always too loud when I turn on	<ul style="list-style-type: none"> ■ the 'max on volume' setting is not set too high.
When Zone 2 is put into standby, the main zone is also switched off	<ul style="list-style-type: none"> ■ the 'zone standby' setting in the setup menu is set to LOCAL.
When a USB memory device is connected, 'USB' is not shown in the network client's list of folders	<ul style="list-style-type: none"> ■ a USB memory device is connected that conforms to the mass storage class. ■ a USB hub is not being used.
If files on a USB memory device cannot be played:	<ul style="list-style-type: none"> ■ the USB device is formatted in FAT16 or FAT32. ■ the USB device does not have multiple partitions. ■ the files are in a compatible format.
If files on a computer cannot be played	<ul style="list-style-type: none"> ■ the files are in a compatible format. ■ the computer is connected via a network and not USB – the AVR400 USB port cannot be used for a direct connection to a computer
If you cannot connect to a wired network	<ul style="list-style-type: none"> ■ the Ethernet cable you are using is correctly connected between the AVR400 and the network hardware. ■ the network is set up for fixed IP addressing and you have the AVR400 set to use DHCP. ■ the network is set up for DHCP and you have the AVR400 set to use fixed IP addressing.
If you cannot connect to a favourite internet radio station	<ul style="list-style-type: none"> ■ the station is still broadcasting or is not congested – try again later.
If the internet radio station sound quality is poor or broken	<ul style="list-style-type: none"> ■ the radio station does not have a low bit rate (use the INFO key to find this or look on the OSD). ■ the network is not slow or congested.



specifications

Continuous power output, per channel, 8Ω	
2 channels driven, 20Hz - 20kHz, <0.02% THD	100W
2 channels driven, 1kHz, 0.2% THD	125W
7 channels driven, 1kHz, 0.2% THD	90W
Residual noise & hum	<0.3mV
Inputs	
Line inputs:	
Nominal sensitivity	1V, 2V, 4V (user adjustable)
Input impedance	47kΩ
Signal/noise ratio (CCIR, 100W)	100dB
Preamplifier outputs	
Nominal output level	1V RMS
Output impedance	560Ω
THD+N (20Hz–20kHz)	-100dB
Video inputs	
Component video signal/noise	85dB
Composite video signal/noise	70dB
Headphone output	
Maximum output level into 32Ω	2Vrms
Output impedance	<5Ω
General	
Mains voltage	110–120V or 220–240V, 50–60Hz
Power consumption (maximum)	1.5kW (Thermal dissipation approx. 5200 BTU/hour)
Power consumption (idle, typical)	100W (Thermal dissipation approx. 340 BTU/hour)
Power consumption (standby)	<0.5W
Dimensions W x D (including speaker terminals) x H (including feet)	433 x 425 x 171mm
Weight (net)	15.5Kg
Weight (packed)	20Kg
Supplied accessories	Mains lead CR102 remote control 4 x AAA batteries Manual DAB aerial FM aerial AM loop aerial Calibration microphone
E&OE	
NOTE: All specification values are typical unless otherwise stated.	

Continual improvement policy

Arcam has a policy of continual improvement for its products. This means that designs and specifications are subject to change without notice.

product guarantee

Worldwide Guarantee

This entitles you to have the unit repaired free of charge, during the first two years after purchase, provided that it was originally purchased from an authorised Arcam dealer. The Arcam dealer is responsible for all after-sales service. The manufacturer can take no responsibility for defects arising from accident, misuse, abuse, wear and tear, neglect or through unauthorised adjustment and/or repair, neither can they accept responsibility for damage or loss occurring during transit to or from the person claiming under the guarantee.

The warranty covers:

Parts and labour costs for two years from the purchase date. After two years you must pay for both parts and labour costs. **The warranty does not cover transportation costs at any time.**

Claims under guarantee

This equipment should be packed in the original packing and returned to the dealer **from whom it was purchased**. It should be sent carriage prepaid by a reputable carrier – **not** by post. No responsibility can be accepted for the unit whilst in transit to the dealer or distributor and customers are therefore advised to insure the unit against loss or damage whilst in transit.

For further details contact Arcam at:

Arcam Customer Support Department,
Pembroke Avenue, Waterbeach, CAMBRIDGE, CB25 9QR, England

or via www.arcam.co.uk.

Problems?

If your Arcam dealer is unable to answer any query regarding this or any other Arcam product please contact Arcam Customer Support at the above address and we will do our best to help you.

On-line registration

You can register your product on-line at www.arcam.co.uk.

device code tables

tableaux des codes d'unité source

code-tabelle für fremdgeräte

tabellen apparaatcodes

TV	
888	0294
A.R. Systems	0067 0382 0586 0404 0485
Accent	0039 0067 0586
Accusound	0890
Acoustic Research	1299
Acoustic Solutions	1179 1067
Acura	0039
Adcom	0655
Addison	0683 0138
ADL	1247 0920
Admiral	0123 0193 0448 0294
Advent	0906
Adyson	0247 0246
AEA	0067 0586
AEG	0636 1067 1179 1193
Afrtron	0921
Agashi	0294 0246 0247
Aiko	0039 0067 0586 0246 0065 0463 0910 0294 0247
Aim	0067 0586 0783 0238 0736 0728 0664 0404 0485 0636 0529
Aiwa	1535
Akai	0039 0238 0586 0067 0463 0065 0783 0193 0759 0744 0736 0728 0745 0632 0578 0510 0247 0294 0661 0246 0208 0407 0636 1067 0503 1289 1278
Akashi	0890 0039
Akiba	0485 0067 0586
Akira	0448 0783 0067
Akito	0067 0586
Akura	0067 0294 0586 0698 0039 0744 1393
Alaron	0246
Alba	0039 0067 1067 0586 0744 0448 0400 0698 0246 0193 0517 0473
Alkos	0065
Allorgan	0247
Allstar	0067 0586
All-Tel	0895 1299
Amplivision	0247 0400
Amstrad	0039 0067 0294 0463 0586 1067
Anam	0067 0586 0039 0680
Anam National	0067 0586 0680
Andersson	1193 1179
Anglo	0039 0294
Anitech	0039 0294 0067 0586
Ansonic	0400 0067 0586 0039 0698 0404 0193
AOC	0655 0039 0090 0123 0138 0208
Aolinpike	0294
Apex Digital	1247
Apollo	0503
Arc en Ciel	0139

Arcam	0246 0247
Arçelik	0744
Ardem	0744 0516 0663 0067 0586
Arena	0067
Aristona	0586 0067
Arthur Martin	0193
ASA	0135 0376 0100 0193
Asberg	0067 0586
Asora	0039
Astra	0067 0586
Asuka	0247 0246 0294
ATD	0728
Atlantic	0067 0586 0246
Atori	0039
Auchan	0193
Audiosonic	0039 0067 0404 0850 0586 0139 0744 0745 0247 0400 0294 0516
Audioton	0247 0516 0400 0294
Audioworld	0728
Aumark	0090
Autovox	0247
AWA	0039 0404 0067 0586 0246 0636 0247 0138 0294 1406 0208 0728
Axxent	0039
Axxon	0744
B&D	1247
Baier	0906
Baihe	0039 0294
Baile	0039 0404 0691
Baird	0373 0139 0247 0238 1226 0636
Bang & Olufsen	0595
BaoHuaShi	0294
Baosheng	0039
Barco	0193
Base	0810
Basic Line	0039 0404 1179 0067 0193 0698 0586 0247 0485 1067
Bastide	0247
Bauer	0039 0728 0736 0294
Baur	0039 0067 0542 0225 0586 1535
Bazin	0247
Beaumarck	0208
Beijing	0039 0238 0256 0294 0404 0512 0691
Beko	0400 0744 0516 0065 0745 0067 0448 0586 0636 0838
Belson	0728 1221
Bennett	0586 0067
Beon	0067 0586 0448
Berthen	0698 0586
Best	0400
Bestar	0067 0586 0400 0404
Bestar-Daewoo	0404
Binatone	0247
Black Diamond	0850 1067 0586 1193 0783 0617
Black Strip	0065

Blaupunkt	0225 0230 0357 0485 0200
Blauren	0404
Blue Sky	0067 1067 0586 0698 0744 1179 0517 0745 0655 1939 0485 1221 0838 1393
Boots	0247 0039
Bork	1393
Bosch	0357
BPL	0067 0586 0926
Brandt	0139 0655 0365 0373 0590
Brandt Electronique	0365
Brinkmann	0067 0586 0698 0448 0516
Brionvega	0067 0586
Britannia	0246 0247
Brother	0294
Bruns	0516
BSR	0193
Bush	0039 1067 0067 0744 0698 0404 0193 0728 0294 0517 0238 0247 0586 0808 1289 1278 0617
Caihong	0039
Caishi	0921
Cameron	0586
Camper	0067 0586 0516
Caponic	0294
Carad	0640 0067 0586 0698 1067
Carena	0485 0067 0586
Carrefour	0100 0067 0586
Carver	0200
Cascade	0039 0067 0586
Casio	0067 0586 0193
Cathay	0067 0586
CCE	0067 0247 0586
Celestial	0850
Centrex	0810 0921 0728
Centrum	1067
Centurion	0067 0586
CGE	0104 0448 0400 0193
Changcheng	0039 0294 0404 0691
Changfei	0039 0404
Changfeng	0294 0783
Changhai	0039
Changhong	0850 0039 0294 0538
Chengdu	0039
Chimei	1535
Ching Tai	0039
Chun Yun	0039
Chunfeng	0039 0294
Chung Hsin	0138
Chunsun	0039
Cimline	0039
Citizen	0090
City	0039
Clarivox	0067 0448 0586 0100
Clatronic	0067 0400 0744 0294 0586 0247 0039 0636 1193
Clayton	1067
CMS	0246
CMS hightec	0247

Cobolt	0921
Concorde	0039
Condor	0067 0400 0586 0246 0039 0448 0193 0294
Conia	0784 0850
Conrac	0838
Conrad	0067 0586
Conrowa	0039 0294 0728 0783 1200
Contec	0039 0246 0294 0067 0586
Continental Edison	0139 0517
Cosmel	0039 0067 0586
CPTEC	0655 1393
Crosley	0104 0193
Crown	0039 0742 0067 0400 0516 0586 0448 0517 0744 0636 0745 0238 0683 1067 0698
CS Electronics	0246
Curtis Mathes	0090 0123
Cytronix	1328
D.Boss	0067
Daewoo	0664 0691 0529 0404 1939 0067 0586 0039 0246 0247 1167 0208 0200 0910 0138 0906 0895 0728 0744 0736 0808
Dainichi	0246
Dansai	0067 0586 0294 0065 0246 0039 0247 0238
Dantax	0400 0516 0744 1067 0636 0745
Datsura	0238
Dawa	0039 0067 0586
Daytek	0728 0736 1406 0294
Dayton	0039
Daytron	0039 0404 0067 0586
Dayu	0404 0691
de Graaf	0238 0578 0193
DEC	0890 0921 0926
Decca	0067 0586 0247 1167
Deitron	0067 0586 0404
Denko	0294
Denver	0067 0586 0636 1219 0617
Desmet	0067 0586 0039
Diamant	0067 0586
Diamond	0294 0728 0039 0855 0246 0890 0850 0926 0736
DiBoss	0067 0586
Digatron	0067 0586
Digihome	1179
Digiline	0067 0586 0135 0698
DigiLogic	0067 0586
Digimate	0920
Digitex	0850
Digitor	0067 0586
DigiX	0910
DiK	0067 0586
Dixi	0039 0067 0586 0247
DL	0921 0810 0067 0617 0895 1393

Domeos	0698 0067 1067
Domland	0424
Dongda	0039
Donghai	0039
Dream Vision	1734
DSE	0850 0728
DTS	0039
Dual	0247 0373 0067 0586 0382 0424 0193 1167 0661 1179 1067 0808 1193
Dual Tec	0247
Dumont	0100 0247
Dunai	0193
Durabrand	0067 0208 0586 1067
Dux	0067 0586
D-Vision	0067 0586
DXV	0921
Dynatech	0247
Dynatron	0067 0586
e:max	0636
Easy Living	1278 1289 1247 0907
Ecco	0803 0736 0728
ECE	0067 0586
Edison-Minerva	0517
Elbe	0640 0400 0193 0067 0586 0247
Elciti	0193
Electrograph	1785
Elekta	0039 0067 0586 0294
Elfunk	1238 1067
ELG	0067 0586
Elin	0067 0246 0578 0586 0135 0193 0039
Elite	0067 0586
Elta	0039 0294 0246
Emerson	0208 0744 0067 0586 0100 1939 0516 0400 0193 0698
Enzer	0783 0803 0890
Erae	1401 1221
Erres	0067 0586
ESC	0067 0586 0247
Estèle	0193
Ether	0039
Etron	0039 0067 0586 0850 0193
Eurofeel	0294 0247
EuroLine	0067
Euroman	0246 0294 0067 0586 0247 0400
Europa	0067 0586
Europhon	0067 0193 0247
Evesham	1278 1289
Excell	0067 0586
Excello	1067
Expert	0193
Exquisit	0067 0586
Fagor	0067 0586
FairTec	1221
Family Life	0067 0586
Feilang	0039
Feilu	0039
Feiyan	0294
Feiyue	0039
Fenner	0404 0039

Ferguson	0067 0139 0655	G-Hanz	1393	Highline	0294 0067 0586	Interbuy	0039 0067 0294	KLL	0067	Madison	0067 0586	Mirai	1681
	0365 0373 0590	Giant	0247 0039	Hinari	0039 0238 0067		0542 0586	Kneissel	0067 0400 0640	Magnadyne	0193	Mitsubishi	0138 0123 0542
	0586 0065 0683	Go Video	0090		0586 0193 0473	Interfunk	0067 0193 0586		0404 0529 0586	Magnafon	0246		0208 0067 0586
	0138 0578 0473	Goldfunk	0698	Hisawa	0517 0294		0542 0357 0400	Kobra	1328	Magnavox	0067 0586 0736		0238 1067 1423
	1067	Goldhand	0246		0485 0640 0744	Internal	0067 0586 0529	Kolin	0138		0810 0783	Mitsuri General	0193
Fidelity	0193 0246 0542	GoldStar	0067 0039 0208	Hisense	1393 0238 0039		0404 1939	Kolster	0067 0586	Magnum	0744 0067 0586	Mivar	0246 0639 0400
	0067 0586 0294		0400 0407 0247		0538 0783 0728	International	0246	Kongque	0039 0294		0745 1319		0247
Filsai	0247		0586 0246 0193	Hitachi	1200 1238 0586	Intervisio	0067 0247 0485	Konichi	0039	Mandor	0294	Monaco	0039
Finlandia	0238 0376 0578	Gooding	0745 0485		1606 0039 0511		0294 0407 0516	Konka	0067 0586 0744	Manesth	0067 0247 0586	Moree	0067
	0193 0373	Goodmans	0517		0608 0138 0774	Ipure	0400 0424 0517		0448 0617 0784	Manhattan	0067 0906 0586	Morgan's	0067 0586
Finlux	0067 0135 0100		0664 0745 1289	Hitachi Fujian	1067 1511 0139	Irradio	0193 0039 0586	Kontakt	0517		0698 1067 0193	Motorola	0123
	0586 0744 0376		0529 0586 0247		0193 1255 0664		1406	Korpel	0067 0586	Maqma	1328	MTC	0090 0400 0542
	0247 0193 0745		0744 0698 0373		0208 0503 0247	IRT	0039 0067 0586	Korting	0400	Marantz	0067 0586		0039 0238 0256
	0661 0522 0510		1939 0404 1193		0373 0538 1193	Isukai	0728	Kosmos	0067 0586	Mark	0067 0586 0247	Multitec	0067 0586 0516
	0503 0448 0636		0294 0039 0517		0578 0529 1179	ITC	0744	Kottron	0294		0246 0404 0039		0698 1067
	0838 1278		0665 0510 0590		1200 0510 0067		0247	Koyoda	0039	Mascom	0744 0745		0294
Firstar	0039		0617 1406 1179		0586 1167 0135	ITS	0067 0294 0246	Kreiden	0906	Master's	0529 0067		0247 0067 0400
Firstline	0039 0067 0586		0400		0522 0907	ITT	0039 0586	KTV	0247	Masuda	0039 0294 0067		0586 0294
	0246 0247 0404		0783		0138 0067 0586		0193 0510 0578	Kuaile	0039 0294	Matsui	0039 0067 1193	Murphy	0246 0193
	0698 0744 0193		0683 0200 0067		0890 0529		0503 0376 0238	Kuba	0193		0586 0193 0065	Musikland	0067 0586
	1939 0238 1067	Gorenje	0586		0890 0529	ITT Nokia	0640	Kuba Electronic	0193		0473 0238 0247	MyCom	1406 0208
	1221 0838 1393	GP	0586		0890 0529		0578 0193 0503	Kulun	0039	Matsushita	0680	Myrad	0586 0067
	1193 1401	Gradiente	0586		0890 0529		0510 0376 0238	Kunlun	0238 0256 0294	Matsviama	0617	NAD	0208 0895 0193
Fisher	0247 0238 0400	Graetz	0586		0890 0529		0636 0640 0661	Kunlun	0404 0691	Maxam	0294	Naiko	0067 0636 0586
	0193		0586		0890 0529		0640	Kyoshu	0448 0294	Maxdorf	0803 0728 0736	Nakamura	0404 0067 0586
Flint	0067 0485 0586	Granada	0586		0890 0529	ITV	0067 0294 0586	Kyoto	0193 0246 0247		0294	Nanbao	0039 0294
	0640 0294		0586		0890 0529		0404	L&S Electronic	0895 0744		0294	Nansheng	0294
Force	1179		0586		0890 0529	Jean	0039	LaSAT	0516 0400		0294	Naomis	0193
Formenti	0067 0193 0586		0586		0890 0529	JEC	0065	Lavis	1067 0067 0193		0294	NAT	0256
	0516 0246		0586		0890 0529	Jialicai	0039 0294	Leader	0039	Maxent	1785	National	0256 0238 0538
Formenti-Phoenix	0246		0586		0890 0529	Jinfeng	0238 0256	Lecson	0067 0586	MCE	0039	NEC	0200 0617 1200
	0123		0586		0890 0529	Jinque	0039 0294	Legend	0039	Mediator	0067 0586		0208 0039 0906
Fortress	0067 0586 0400		0586		0890 0529	Jinta	0039 0294	Lenco	0039 0067 0193	Medion	0698 0744 0838		0485 0404 0247
Fraba	0039 0067 0586		0586		0890 0529	Jinxing	0039 0294 0728		0404 0586 0617		1067		0067 0586 0294
Friac	0400 0529 0640		0586		0890 0529	JMB	0067 0529 0664	Lenoir	0039 1219 0920	MegaDrive	1289	Neckermann	0067 0400 0586
Frontech	0193 0294 0247		0586		0890 0529		0404 0586 0473	Lenox	1219	Megas	0640		1535 0230 0193
	0039		0586		0890 0529		0906 0926	Levis Austria	0067 0586		0640		0357 0448 0247
Fuchsware	0810		0586		0890 0529	JNC	0742	Lexsor	1226	Megatron	0208	NEI	0067 0586 0193
Fujimaro	0895		0586		0890 0529	Jubilee	0586	Leyco	0067 0294 0586	MEI	1067 0067 0586	NEO	0784
Fujitsu	0713 0883 0247		0586		0890 0529	Juhua	0294	LG	1179 0208 0067	Meile	0294	Neovia	0895 1401 0906
	0193 0039 0382		0586		0890 0529	JVC	0683 0761 0636		0586 0906 0744	Meletronic	0039 0376 0067		1406 1221
	0667 0586		0586		0890 0529		0538 0713 0448		1667 0674 0636		0542 0139 0373	Netsat	0067 0586
Fujitsu General	0039 0247 0193		0586		0890 0529		0123 0680		0090 0138 1295		0542 0139 0373	Neufunk	0067 0039 0586
Fujitsu Siemens	1328 1289 1278		0586		0890 0529		0407 0039 0745		0407 0039 0745		0193 0135 0247		0640 0744
	1193 0838		0586		0890 0529		0247 0246 0193		0404 0510 0522		0404 0510 0522		0373 0247
Funai	0294 1067 0698		0586		0890 0529		0067 0586 0485		0246 0586 0664		0225 0691 0744		0067 0039 0586
	1535 0744		0586		0890 0529		0407 0294		0246 0586 0664		0039 1067 0208		0640 0744
Furi	0294		0586		0890 0529		0586 0713 1278		0246 0586 0664		0680 0090		0373 0247
Furichi	0890		0586		0890 0529		1289		0246 0586 0664				0640 0744
Futronic	0294 0890 0728		0586		0890 0529				0246 0586 0664				0640 0744
Future	0067 0586		0586		0890 0529				0246 0586 0664				0640 0744
Gaba	1067 0067		0586		0890 0529				0246 0586 0664				0640 0744
Galaxi	0067 0586 0193		0586		0890 0529				0246 0586 0664				0640 0744
Galaxis	0400 0448 0067		0586		0890 0529				0246 0586 0664				0640 0744
	0586		0586		0890 0529				0246 0586 0664				0640 0744
Galeria	0039		0586		0890 0529				0246 0586 0664				0640 0744
Garza	0586		0586		0890 0529				0246 0586 0664				0640 0744
Gateway	1785		0586		0890 0529				0246 0586 0664				0640 0744
GBC	0193 0039 0404		0586		0890 0529				0246 0586 0664				0640 0744
GE	0373 0208 0123		0586		0890 0529				0246 0586 0664				0640 0744
	0590 0139 0365		0586		0890 0529				0246 0586 0664				0640 0744
	0655		0586		0890 0529				0246 0586 0664				0640 0744
Geant Casino	0193		0586		0890 0529				0246 0586 0664				0640 0744
GEC	0067 0193 0247		0586		0890 0529				0246 0586 0664				0640 0744
	0586		0586		0890 0529				0246 0586 0664				0640 0744
Geloso	0039 0193 0404		0586		0890 0529				0246 0586 0664				0640 0744
General	0139		0586		0890 0529				0246 0586 0664				0640 0744
General Electric	0373		0586		0890 0529				0246 0586 0664				0640 0744
General Technic	0039		0586		0890 0529				0246 0586 0664				0640 0744
Genesis	0039 0067 0586		0586		0890 0529				0246 0586 0664				0640 0744
Genexxa	0193 0067 0586		0586		0890 0529				0246 0586 0664				0640 0744
	0039		0586		0890 0529				0246 0586 0664				0640 0744
Gericom	0895 1328 1247		0586		0890 0529				0246 0586 0664				0640 0744
	0910 0838		0586		0890 0529				0246 0586 0664				0640 0744
Gevalt	1401 1221		0586		0890 0529				0246 0586 0664				0640 0744
			0586		0890 0529				0246 0586 0664				0640 0744

TV (cont.)		TV (cont.)		TV (cont.)		TV (cont.)		TV (cont.)		TV (cont.)		TV (cont.)	
Normerel	0067 0586	Philix	0193	Rank Arena	0632 0783	Sanyo	0238 1238 0400	Skysonic	0783	Sydney	0246 0247	Tennessee	0067 0586
Novak	0067 0586	Philharmonic	0247	RBM	0100		0246 0247 0039	Skyworth	0067 0586 0039	Synco	0090 0123 0208	Tensai	0067 0586 0247
Novatronic	0067 0135 0404 0586	Philips	0067 0586 0802	RCA	0655 0090 0123		0538 0193 0067		0294 0728 0783	Syoline	0067 0586		0039 0135 0404
Nurnberg	0193		0208 0138 0404		0208 0590 0365		0138 0586 0516	Sliding	0895 0910	Sytong	0246		0407 0745 0193
NU-TEC	0485 0728 0850	Phocus	1319 0744		0648 0373 0783	Sanyuan	0200 0294 1067	SLX	0698	T+A	0477	Tenson	0039
	0067 0586 0736 0294	Phoenix	0067 0586 0400	Realistic	0208	Save	0039 0123	Smaragd	0517	Tacico	0208 0039	Tesla	1067 0067 0698
O.K.Line	1067		0516 0193 0246	Recor	0067 0448 0586	SBR	0067 0586	S-Media	1247	Taishan	0039 0404		0744 0745 1167
Oceanic	0193 0238 0503 0578 0510	Phonola	0067 0586 0246	Rectiligne	0067 0586	Schaub Lorenz	0578 0744 0636	Soemtron	0895 1328	Tandberg	0139 0193		0855 0783 0586
Odeon	0294	Pilot	0586 0067 0742 0736	Rediffusion	0578 0376		0516 0404 1221	Sogo	1406	Tandy	0123 0247 0193	Tevion	1328 1278 1289
Okano	0400 0067 0586 0294 0039	Pioneer	1290 0790 0200 0139 0193 0067 0586 0373 0516 0542	Redstar	0067 0586		1393 1401 0906	Solavox	0193 0578 0067 0586	Targa	1401 1221 0648		0067 0586 0838
OKI	1067		0586 0373 0516	Reflex	0067 0586 1067 0698	Schneider	0067 1167 0586 0698 0424 0382 0373 0247 1067 0193 0744 1939 0100	Songba	0039	Tashiko	0247 0680 0200 0246 0193	Texet	0246 0247 0404 0039
Olidata	1406	Pionier	0400 0516	Relisys	0895 0906 0907 1328 1406			Soniko	0783	Tatung	0039 0067 1278 0090 0586 0247 1401 1289 1221	Thomson	0590 0655 0373 0139 0783 0365 0067 0586 0246
Omega	0294	Plantron	0067 0586 0294 0039	Reoc	0744 0664 1939	Schönteck	1067	Soniq	1328	TCL	0655 0728 0736		0067 0586 0246
Omni	0810 0921 0728	Playsonic	0744 0067 0247 0745	Revox	0067 0838 0586 0400	Scotch	0208	Sonitron	0238 0400 0247	TCM	0744 1319 0838	Thorn	0065 0138 0139 0067 0104 0373 1535 0529 0542 0586 0365 0404 0100
Onida	0683	Polars	0067	Rex	0193 0294	Scotland	0193	Sonoclar	0067 0586	Teac	0039 0728 0067 0294 1067 0586 0448 0542 0742 0485 0698 0247 0736 1939 0208 0200 0744 1179 1785 1393 0617		0138 0373 0139 0365 0529 0065 0123
Onn	1179 0586	Polaroid	0895	RFT	0400 0294 0067 0586 0516	Scott	1219 0208	Sonoko	0039 0067 0586 0294 0247	TEC	0247 0039 0365 0067 0586 0193	Tiane	0123
Opera	0067 0586 0744	Policom	0139 0193 0100 0104	Rhapsody	0246	Sears	0208	Sonolor	0193 0238 1535 0578	Tech Line	0067 0586 0698 1193	Tiny	1226 1299
Optimus	0680	Poppy	0039	Ricoh	0067 0586	Sealver	0586 1067 0067	Sontec	0067 0586 0400 0039	Tech Lux	1219	TMK	0208
Op-tonica	0123	Portland	0404 1939	Rinex	0803 0448 0728 0294 0736	SEG	1067 0247 0067 0294 1193 0586 0698 0517 0039 0193 0664 0246 1939 1179	Sony	1535 1681 0680 1781 0383	Technics	0680	Tokai	0039 0294
Orava	1067	Powerpoint	0517 0067 0586 0728	R-Line	0067 0586 0193	SEI	1535 0193 0067 0586	Sound & Vision	0404 0067 0586	TechniSat	0067 0586 0193	Tokyo	0246 0065
Orbit	0067 0586	Precision	0247	Roadstar	0294 0448 0067 0586 0744 0698 1219	Sei-Sinudyne	1535 0067 0586	Sounddesign	0208	Technisson	0744 1319	Tongguang	0294
Orion	0067 0473 0744 0586 0039 0294 0910 1226	Premier	0039 0294 0921	Rodex	0067 0586	Seleco	1247	Soundwave	0067 0448 0586 0745	Techno	1067	Tongtel	0810 0617
Orline	0067 0586	Prima	0039 0294 1299 1226	Rolsen	1401 1221 0067 0586	Sencora	0039	Sowa	0090 0256 0208	Technol Ace	0728 0294 0664 0404 0246	Top Show	0728 0803 0448 0039 0294 0736
Ormond	0698 1067 0067 0586	Princess	0728	Rover	0907	Sentra	0065 0039	Soyea	0803	Technosonic	0067 0586 0529 0910	Topline	1067 0698
Osaki	0247 0294 0067 0404 0586	Prinston	1067	Rowa	0067 0294 0728 0742 0247 0039 0246 0736 0617 0586	Serie Dorada	0208	Spectra	0039	Techwood	1193 1067	Toshiba	1538 0538 0680 0090 0039 0065 1734 1194 1319 1295 0744 0100 0123 0294 0648 0674 0247 0139 0225 0728 0067 1067
Osio	0067 0586	Profex	0039 0193	Saba	0139 0655 0193 0590 0365 0373 0578 0680 0744 0640 0485 0860 1343 0648	Serino	0640 0485 0246 0123	Ssanyong	0039	Teckton	1406		0586 0485 0617 0542 0294 0448 0039 1393 0810
Osume	0067 0586	Profi	0039	Sagem	0640 0485 0860 1343 0648	Shancho	0294	Staksonic	0039	Tecmimagen	0586	Transtec	0246
Otto Versand	1535 0067 0247 0373 0542 0123 0586 0225 0139 0256 0039	Profitronic	0067 0586	Saige	0039	Shanghai	0294	Standard	0039 0067 0247 0586 1067 0404	Teco	1343 0039 0123 0208 0294 0683	Triad	0067 0586 0039
Pacific	0067 0586 1167 0744 1067 0473	Proline	0067 0586 0655 0664 1406 1067	Saisho	0039 0664 0404 0294 0247 0193	Shen Ying	0294	Starite	1067	Tedex	0247 0728 0736 0636 0448 0067 0039 0238 0921 0617 0586 0294	Trident	0247
Pael	0246	Prosonic	0067 0586 0400 0404 0910 0698 1406 0744 0246 0247 0636 0745 1226	Saivod	0067 0586 1193 0698 0742 1067	Shencai	0039 0294	Starlite	0039 0193 0067 0586 0294	Telacor	0067 0586 0193 0247 0424	Tristar	0294
Palladium	0400 0448 0067 0744 1167 1535 0230 0586 0357 0193 0247	Provision	0529 0067 0586 1067 0744	Sakai	0193	Sheng Chai	0039	Stern	0193 0294	Telefunken	0655 0590 0104 0139 0617 0728 0365 0373 0742 0850 0926 0784 0810 0921 0783 0736 0067 0586 0516 0744 0376	Trion	1278
Palsonic	0294 0803 0067 0247 0407 0728 0586 0448 0808 1226 1299	PVision	1221 0906	Sakyno	0485	Sheng Chia	0039 0123	Strato	0067 0586 0294 0039	Televia	0139 0373	Triumph	0376 0586 0067
Panama	0039 0247 0294 0246 0067 0586	Pye	0067 0586 0404	Salora	0193 0578 0238 0510 0661 0808 1401	Shenyang	0039 0294 0783	Strong	1193 1179 1067 0067 0586	Telecom	0067 0586 0193 0247 0424	Tuntex	0039
Panasonic	0680 0256 0067 1340 0586 0193 0238 0538 0926 0883 0578 0138	Pymy	0039	Sals	0365	Sherwood	0039	Sstylandia	0247	Telegazi	0067 0193 0294 0586	Uher	0067 0586 0404 0448 0516 0400 0510
Panavision	0067 0586	Qingdao	0238 0256 0294	Sampo	1785 0039 0123 0208 0680	Shintoshi	0067 0586	Sungoo	1278	Telescan	0039 0067 0586	Ultrasound	0404 0246 0193 0067 0586
Panda	0039 0238 0256 0294 0538 0728 0810 0736 0921	Quelle	0067 1535 0100 0104 0139 0542 0247 0357 0135 0698 0586 0225 0230 0294 1067 0376 0039	Samsun	0674 0796 0090 0648 0208 0617 0123 0039 0586 1279 0512 1265 0067 0294 0247 0400 0238 0256 0246 0193	Siaram	0067 0586 0473 0404 0208	Sunic Line	0067 0586	Teleton	0247 0193	United	0744 0067 0745 0586 1067 0617
Papouw	0067 0586	Quadro	1179 1193	Sant	0039	Silver	0485 0067 0586 0745 0193	Sunkai	0485 0640 0067 0586 0517 0895	Televideo	0193 0246	Universal	0744 0067 0586
Pathe Cinema	0193 0246 0400	Quasar	0680 0895 0039	Sansui	0067 0759 0586 0736 0632 0485 0783 1401 1221 0728 0294 0744 1278	Shivaki	0067 0586 0473 0404 0208	Sunny	0067	Tempst	0039 0067 0586 0294		
Pathe Marconi	0139	Quelle	0067 1535 0100 0104 0139 0542 0247 0357 0135 0698 0586 0225 0230 0294 1067 0376 0039	Sandra	0246 0247	Show	0448 0039 0728 0294 0736 0067 0193	Sunstar	0067 0586 0039 0294				
Pausa	0039	Radialva	0139 0193 0067 0586	Sanjian	0294	Siarem	0193	Sutrun	0039				
Peng Sheng	0921	Radiola	0067 0586 0247	Sansui	0067 0759 0586 0736 0632 0485 0783 1401 1221 0728 0294 0744 1278	Siemens	0067 0225 0230 0357 0586	SVA	0617 0728 0294 0485 0895 0238 0736				
Penney	0208 0090	Radiomarelli	0067 0586	Sant	0039	Siera	0067 0586 0617	Svasa	0728 0238 0736 0294				
Perdio	0193 0067 0246 0586	Radiometre	0744	Sant	0039	Siesta	0400	Swisstec	0910 1406 0895				
Perfekt	0067 0586	RadioShack	0067 0586 0208 0586			Silva	0067 0586 0246						
Philco	0104 0448 0067 0193 0586 0400 0208 0511	Radiotone	0039 0067 0586 0400 0448 0698 0294 1067			Silva Schneider	0783						

Universum	0838	1067	0067
	0104	1193	0294
	0376	0400	0698
	0135	0510	0225
	0503	1179	0542
	0522	0230	0448
	0100	0193	0586
	0357	1535	0247
	0139	0661	0039
	0200	0648	
Univox	0067	0586	0193
Utax	0193		
V7 Videoseven	1785	0208	0910
	1406	1247	0648
	1681	1535	
Vanguard	0067	0586	
Vestel	0067	1067	1193
	0698	0193	0247
	0586		
Vexa	0039	0067	0586
Victor	0683	0680	
Videocon	0538		
Videologic	0246		
Videologique	0246	0247	
VideoSystem	0067	0586	
Videotechnic	0246	0247	0404
Videoton	0193		
Vidtech	0208		
Viepia	0906		
ViewSonic	1785		
Visiola	0246		
Vision	0067	0294	0586
	0247		
Vistron	1393		
Vivax	0067		
Vortec	0067	0586	
Voxson	0193	0208	0067
	0586	0448	
Walker	1179		
Waltham	0247	0448	0067
	0586	0698	0139
	1067	0193	0473
Wards	0208		
Warumaiia	0404	0691	0664
Watson	0067	1067	1278
	1289	0586	0193
	0039	0698	0424
	1406	0357	
Watt Radio	0193	0246	0516
Wega	0067	0586	
Wegavox	0039	0067	0586
Weipai	0039		
Welltech	0744		
Weltblick	0067	0586	0247
Weltstar	1067		
Westinghouse	0920		
Weston	0067	0586	
Wharfedale	0067	0926	0921
	0890	0586	0728
	0736		
White	0067	0246	0586
Westinghouse	1939		
Wilson	0586		
Windsor	0698	1067	
Windy Sam	0586		
Wintel	0744		
World-of-Vision	0910	0920	0895
	1319	1328	0907
	1247		
Worldview	0485		
XDome	0538		
Xenius	0664	0691	
Xiahua	0039	0294	0728
	0803		

Xianghai	0039		
Xiangyang	0294		
Xiangyu	0039		
Xihu	0294		
Xingfu	0039		
Xinghai	0294		
Xingyu	0039		
XLogic	0728	0890	
Xoro	1226	1247	
Xrypton	0067	0586	
X-View	1221		
Yamaha	0680	1606	
Yamishi	0485	0067	0586
	0247		
Yingge	0039		
Yokan	0067	0586	
Yoko	0067	0247	0294
	0586	0039	0400
	0246		
Yonggu	0039		
Yoshita	0855		
Yousida	0039		
Yuhang	0039		
YU-MA-TU	0067		
Zaapa	1219		
Zanussi	0247		
Zenith	1939	0208	1295
Zhuhai	0039	0404	
Zonda	0728		

VCR

Accent	0102		
Adyson	0102		
Aim	0308	0672	0378
Aiwa	0030	0378	0382
	0067	0772	1167
	0062		
Akai	0030	0067	0136
	0345	0672	0382
	0270	0378	
Akashi	0102		
Akiba	0102		
Akura	0102		
Alba	0308	0102	0382
	0030	0345	0378
	0111		
Allorgan	0270		
Allstar	0111		
Amstrad	0030	0308	0102
Anitech	0102		
Ansonic	0030		
Aristona	0111		
ASA	0067	0111	
Asuka	0102	0067	0111
	0030		
Audiosonic	0308		
AVP	0382	0030	
AWA	0067	0308	0672
	0073		
Baird	0136	0308	0134
	0030		
Basic Line	0308	0102	0134
Beko	0134		
Bestar	0308		
Black Diamond	0672	0308	
Black Panther	0308		
Blaupunkt	1592	0256	0111
Blue Sky	0067	0378	0102
	0382	0308	0030
	0510	0672	1167
	0772		
Bondstec	0102		
Brandt	0350		
Brinkmann	0378		
Broksonic	0378	0772	0382
Bush	0102	0308	0345
	0382	0030	0378
	0111	0672	0772
Carena	0111		
Carrefour	0075		
Casio	0030		
Cathay	0308		
CGE	0030		
Cimline	0102		
CineVision	1167		
Clatronic	0102	0030	
Combitech	0382		
Condor	0308		
Crown	0067	0308	0510
	0102		
Cyrus	0111		
Daewoo	0308	0672	1167
	0667	0378	0382
	0075		
Dansai	0102	0308	
Dantax	0382	0772	
Daytron	0308		
de Graaf	0072	0196	0111
	0134	0078	
Decca	0030	0111	0097
	0378	0382	
Deitron	0308		

Denko	0102		
Denon	0072		
Diamant	0067		
Diamond	0308		
Digitor	0672		
DSE	0672		
Dual	0111	0308	0030
	0378		
Dumont	0030	0111	0134
Durabrand	0672		
Elbe	0308		
Elcatech	0102		
Elin	0270		
Elsay	0102		
Elta	0102	0308	
Emerson	0102	0075	0030
	1167		
ESC	0308	0270	
EuroLine	0378		
Ferguson	0350	0030	0308
Fidelity	0462	0382	
Finlandia	0134	0111	0072
	0196	0030	0078
	0067	0073	0136
	0256		
Finlux	0030	0111	0134
	0072		
Firstline	0102	0378	0073
	0067	0075	0072
	0308	1167	
Fisher	0134		
Flint	0378		
Frontech	0102		
Fujitsu	0030		
Fujitsu General	0067		
Funai	0030		
Galaxi	0030		
Galaxis	0308		
GE	0350		
GEC	0111		
General Technic	0378		
Genexxa	0134		
Go Video	1167		
Goldhand	0102		
GoldStar	0067	0510	0030
Goodmans	0030	0102	0270
	0308	0067	0111
	0378	0667	0382
	0672		
GPX	0067		
Graetz	0134	0270	
Granada	0134	0078	0111
	0270	0067	0256
	0072	0030	
Grandin	0102	0067	0030
	0308		
Grundig	0377	0111	0256
	0350	0378	0102
	0382	0772	
Haaz	0378		
Hanimex	0382		
Hanseatic	0067	0308	0111
Harwood	0102		
HCM	0102		
Hinari	0102	0382	0308
	0270		
Hisawa	0382		
Hischito	0075		
Hitachi	0072	0196	0030
	0270	0111	0134
Höher	0308	0672	
Hornophon	0111		

Hypson	0102	0378	0308
	0382	0030	0067
	0510		
Imperial	0030	0270	
Ingersoll	0270		
Inno Hit	0270	0308	0102
Interbuy	0067	0102	
Interfunk	0111	0134	
Internal	0308	0667	
International	0308	0667	
Intervision	0030	0308	0067
	0378		
Irradio	0102	0067	0111
	1167		
ITT	0136	0134	0270
ITT Nokia	0078		
ITV	0308	0067	
JMB	0382	0378	
Joyce	0030		
JVC	0097		
Kaisui	0102		
Kambrook	0067		
Karcher	0308		
Kendo	0136	0345	0378
	0102	0067	0308
KIC	0030		
Kneissel	0382	0378	0067
	0308		
Kolster	0378		
Korpel	0102		
Kyoto	0102		
Lenco	0308		
Leyco	0102		
LG	0067	0510	0030
Lifetec	0378		
Loewe	0111	1592	0256
	0067		
Logik	0270	0102	0136
Lumatron	0308		
Lux May	0102		
Luxor	0136	0073	0102
	0134	0078	0345
Magnavox	0111	0672	
Magnum	0672		
Manesth	0102	0075	0111
Marantz	0111		
Mark	0308	0030	
Mascom	0672		
Mastec	0672		
Master's	0308		
Matsui	0378	0067	0270
	0382	0030	0772
Maxton	0111		
Mediator	0111		
Medion	0378	0382	
Melectronic	0030	0067	
Memorex	0134	0030	0067
	0078	0378	
Memphis	0102		
Metronic	0111		
Metz	1592	0377	0866
	0111	0256	0067
Micormay	0378		
Micromaxx	0378		
Migros	0030		
Mitsubishi	0073	0097	0111
	0510	0030	0672
Multitec	0067		
Multitech	0030	0102	0134
Murphy	0030		
Myrrad	0111		

NAD	0134		
Naiko	0672	0378	
National	1592	0256	
NEC	0097	0070	0134
	0067	0308	1167
Neckermann	0111		
Nesco	0102	0030	0382
Neufunk	0067		
Nikkai	0102	0308	
Nokia	0134	0136	0345
	0308	0270	0078
	0072	0111	
Nordmende	0350	0097	0672
NU-TEC	0378		
Oceanic	0030	0350	0078
	0136	0111	0134
Okano	0345	0378	0102
	0308		
Onimax	0672		
Orbit	0102		
Orion	0378	0382	0772
Orson	0030		
Osaki	0030	0067	0102
Osume	0102		
Otto Versand	0111		
Pace	0382		
Pacific	0030		
Palladium	0102	0345	0067
	0270	0378	0462
Palsonic	0102	0030	0672
Panasonic	1592	0256	0866
Pathe Cinema	0073		
Perdio	0030		
Philco	0102		
Philips	0111		
Phoenix	0308		
Phonola	0111		
Pioneer	0097	0111	0072
Portland	0308	0667	
Prinz	0030		
Profitronic	0111	0270	
Proline	0030	0308	0350
	0672		
Proscio	0308		
Prosonic	0308	0030	
Protech	0111	0308	
Provision	0308		
Pye	0111	0030	
Quasar	0308		
Quelle	0111		
Radialva	0067	0102	0111
	0078		
Radiola	0111		
Radionette	1167	0067	
RCA	0136	0350	
Reoc	0378	0667	0308
RFT	0102		
Roadstar	0270	0102	0067
	0308	0772	0111
Royal	0102		

VCR (cont.)

Thomson	0350	0097	0308
Thorn	0134	0067	
Thorn-Ferguson	0350		
Tokai	0102	0067	0134
Tokiwa	0102		
Topline	0378		
Toshiba	0075	0073	0111
	0772	0382	
Towada	0102		
Tradex	0111		
Tredex	0308		
Triad	0308		
Uher	0067	0270	
Ultravox	0308		
Unitech	0270		
United	0378	0772	
Universum	0030	0111	0270
	0067	0136	0378
	0134		
Victor	0097		
Video Technic	0030		
Watson	0111	0382	0308
	0672		
Weltblick	0067		
Wharfedale	0672		
White	0102		
Westinghouse			
World	0378		
Yamishi	0102	0308	
Yokan	0102		
Yoko	0067	0102	0270
Yoshita	0102		
Zenith	0667	1167	
ZX	0378	0382	
Stern	0308		
STS	0072		
Sunkai	0378	0308	
Sunstar	0030		
Suntronic	0030		
Sunwood	0102		
Supra	0067	0270	0378
	0308		
Sylvania	0030	0073	0111
Symphonic	0030	0102	
T+A	0256		
Tandberg	0308		
Tandy	0030	0134	
Tashiko	0030	0078	0270
	0111	0067	
Tatung	0030	0111	0078
	0073	0378	0382
Tchibo	0378		
TCM	0378		
Teac	0102	0030	0308
	0672	0067	0111
	0667		
TEC	0308	0102	
Tech Line	0102		
Technics	0256		
TechniSat	0378		
Tedalex	0067	0378	0672
Teknika	0030	0067	
Telefunken	0672	0350	0308
Telestar	0067		
Teletech	0102	0308	0030
Tenosal	0102		
Tensai	0030	0067	0102
	0308		
Tevion	0378	0672	
Textet	0308		

Thomas	0030		
Thomson	0350	0097	0308
Thorn	0134	0067	
Thorn-Ferguson	0350		
TMK	0270		
Tokai	0102	0067	0134
Tokiwa	0102		
Topline	0378		
Toshiba	0073	0075	0111
	0772	0382	
Totevision	0067	0270	
Towada	0102		
Tradex	0111		
Tredex	0308		
Triad	0308		
Uher	0067	0270	
Ultravox	0308		
Unitech	0270		
United	0378	0772	
United Quick Star	0308		
Universum	0030	0111	0270
	0067	0136	0378
	0134		
Vector	0075		
Vector Research	0070		
Victor	0097		
Video Concepts	0070	0075	
Video Technic	0030		
Video Sonic	0270		
Wards	0030	0072	0078
	0102	0111	0270
Watson	0111	0382	0308
Weltblick	0067		
Wharfedale	0672		
White	0102	0308	
Westinghouse			
World	0378		
XR-1000	0030	0102	
Yamishi	0102	0308	
Yokan	0102		
Yoko	0067	0102	0270
Yoshita	0102		
Zenith	0030	0667	1167
ZX	0378	0382	

VIDAC

Elonex	1302		
Fujitsu Siemens	1302		
Gateway	1302		
Hewlett Packard	1302		
hFX	1302		
Microsoft	1302		
Pinnacle Systems	1477		
Ricavision	1302		
Tenosal	1302		
Trust	1302		
Via Technologies	1302		
XBox	1302		

CBL

@Home	1696		
ADB	1260	1299	
Alice	1654		
Amstrad	1252		
Auna	1299	1260	
Austar	0306		
Cablecom	1612		
Canal Plus	0473		
Com Hem	1696	0847	
Comcrypt	0473		
Daeryung	0507		
Fastweb	1660		
Filmnet	0473		
Foxtel	1252		
France Telecom	0847	1764	
freebox	1512		
Funai	0049		
General	0306		
Instrument			
Jerrold	0306		
KabelBW	1090		
Macab	0847		
Madritel	1260		
MNet	0473	0049	
Motorola	0306	1136	1513
Multichoice	0049	0473	
Nokia	1599		
Noos	0847	1654	
NTL	1090	1098	
Numericable	0847		
Oak	0049		
Ono	1098	0306	
Optus	0306	1090	
Orange	0847	1764	
Pace	1098	1607	1090
Philips	0847	1612	
Premiere	1607		
Sagem	0847	1654	
Samsung	1090	1696	
Scientific Atlanta	0507		
SKY Deutschland	1607		
StarHub	0306		
Tele Danmark	0847		
Tele+1	0473		
Telepiu	0473		
Telewest	1098	1090	
Telsey	1660		
Thomson	1612	1764	
Trans PX	0306		
UPC	1612		
US Electronics	0306		
Virgin Media	1090	1098	
Visiopass	0847		
YouSee	0847		
Ziggo	1599	1696	

CD

Advantage	0062		
AH!	0187		
Aiwa	0187		
Arcam	0187		
Atoll	0187		
Electronique			
Audio Research	0187		
Audiolab	0187		
Audiomeca	0187		
Audioton	0187		
Balanced Audio	0187		
Technology			
Cairn	0187		
California Audio	0059	0333	
Labs			
Cambridge	0187		
Audio			
Carver	0187		
Copland	0423		
Cyrus	0187		
Denon	0033	0796	0656
DKK	0030		
Dual	0033		
Dynaco	0187		
Elektra	0423		
Garrard	0423		
Genexxa	0030	0062	
Goldmund	0187		
Grundig	0187		
Harman/Kardon	0187		
Hitachi	0062		
JVC	0102		
Kenwood	0220	0656	0066
Krell	0187		
Linn	0187		
Loewe	0187		
Magnavox	0187		
Marantz	0187	0656	0059
Matsui	0187		
MCS	0059		
Memorex	0062		
Meridian	0187		
Micromega	0187		
Mission	0187		
Musical Fidelity	0423		
Myryad	0187		
NAD	0751	0030	
Naim	0187		
NSM	0187		
Onkyo	0131		
Optimus	0030	0062	
Orion	0423		
Panasonic	0333	0059	
Philips	0187	0656	
Pioneer	0062		
Primare	0187		
Proton	0187		
QED	0187		
Quad	0187		
Quasar	0059		
Radiola	0187		
Restek	0187		
Revox	0187		
Rotel	0187		
SAE	0187		
Sansui	0187		
Siemens	0187		
Simaudio	0187		
Sony	0030	0520	0187

Tag McLaren	0187		
Tandy	0062		
Teac	0423		
Technics	0333	0059	
Thorens	0187		
Thule Audio	0187		
Traxdata	0656		
Universum	0187		
Victor	0102		
Wards	0187		
Yamaha	0066	0520	0062

TUNER

AEG	1420	1419	
AFK	1419		
Aim	1420		
Aiwa	0151	0219	1088
	1188	1288	1652
	1752		
Akai	0639	1250	1420
All-Tel	1420		
Amstrad	1420		
Anam	0639		
Arcam	0219	1119	1219
	1299	1319	
ASCOMTEC	1419		
Audiolab	1119	1219	1299
	1319	0219	
AudioSonic	1419		
Audiovox	1420		
AudioWorld	1420		
Balanced Audio	1119	1219	1299
Technology	1319	0219	
Bang & Olufsen	0829		
Basic Line	1584		
Belson	1419		
Blue Sky	1420		
Bonnet	1219		
Bose	1259	1385	
Bush	1119	1219	1299
	1319		
Cairn	0219		
Cambridge Audio	1219	0219	
Carver	0219	1119	1219
CCE	1382		
Centrum	1250	1584	1419
Classic	1382		
Clatronic	1250		
Copland	1119	1219	1299
	1319		
Denon	1390	1134	
Denver	1419		
Diamond	1420		
DK digital	1450		
DMTECH	1420		
Dual	1250	1420	1450
Electrocompaniet	1219		
Elta	1420		
Fisher	1831		
Genexxa	0216		

Goldmund	0219	1119	1219
	1299	1319	
Goodmans	0639	1229	1450
	1641	1419	
Grundig	1119	1219	1299
	1319	0219	
Hanseatic	1420		
Harman/Kardon	1334	1119	1219
	1299	1319	0219
HCM	1420		
HE	1419		
Hitachi	1831	1250	1584
	1229		
Hiteker	1419		
Home Tech	1419		
Industries			
Integra	0165	1350	
JVC	0104	1404	1525
Kenwood	1343	1057	1599
	0216	1323	
KLH	1420		
KXD	1419		
Lenoxx	1419	1641	
Lenoxx Sound	1641		
LG	1323		
Linn	0219	1119	1219
	1299	1319	
Loewe	1119	1219	1299
	1319	0219	
Magnavox	0219	1119	1219
	1299		
Magnum	1641		
Marantz	1119	1219	1299
	1319	0219	
Mark	1119	1219	1299
	1319		
MBO	1382		
Medion	1450		
MEI	1420		
Melectronic	0639		
Meridian	1119	1219	1299
	1319		
Metz	1584		
Micromaxx	1450		
Micromega	1119	1219	1299
	1319	0219	
Mustek	1382		
Myryad	1219	1119	1299
	1319	0219	
NAD	0350	0639	
Naim	1119	1219	1299
	1319		
Nexius	1420		
Nikkai	1419		
Nikko	0639		
Norcent	1419		
Okano	0639		
Onkyo	1350	0165	
Optimus	0216	1053	
Orava	1419		
Palladium	1250		
Panasonic	1809	1548	1338
	1793	1795	1339
Paramount Pictures	1250		
Philips	1219	1299	1119
	1319	0219	
Pioneer	1053	0216	1119
	1219	1299	1319
	1489		

ARCAM